

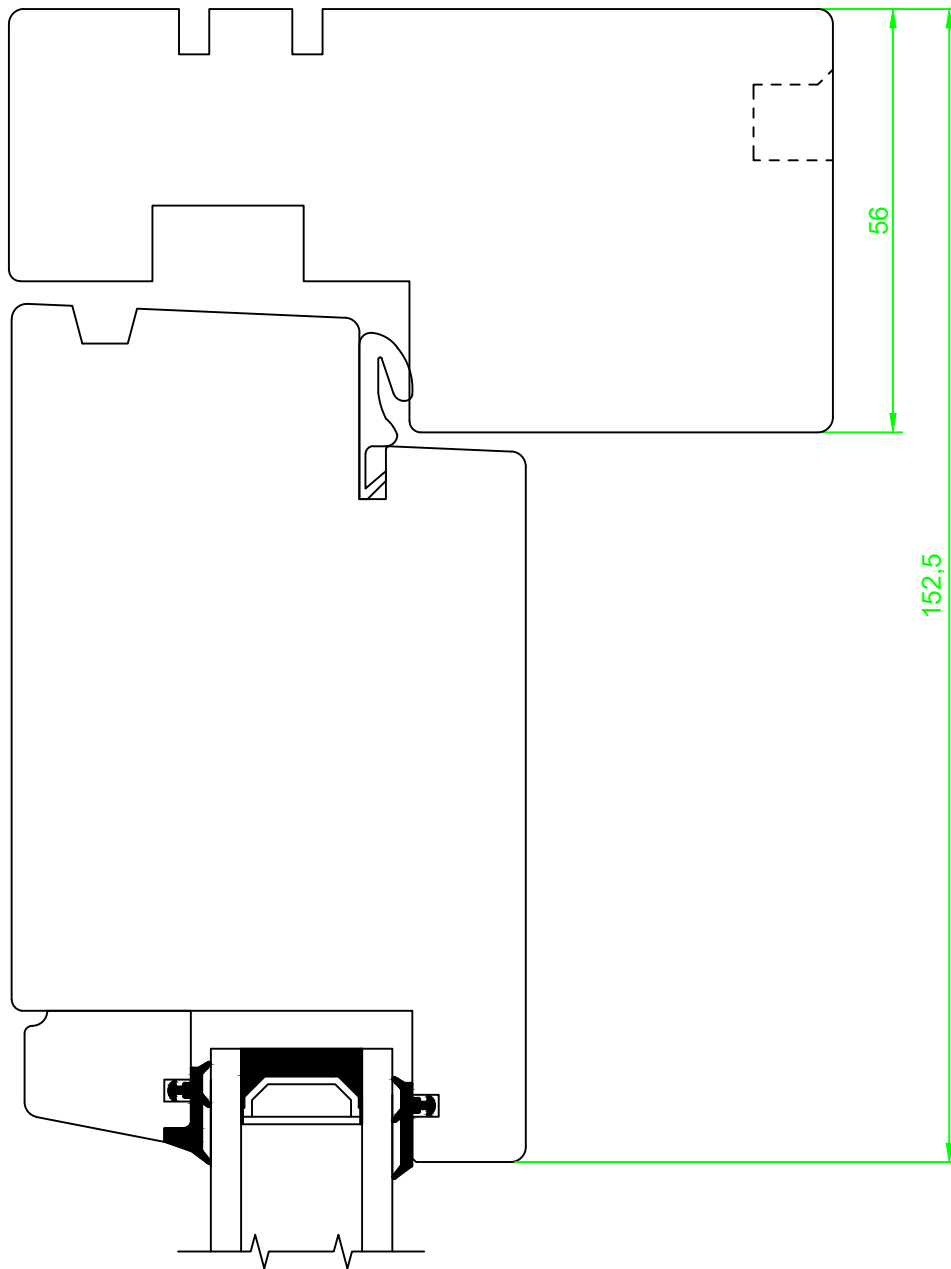



<i>Date.</i> 22.5.2013	<i>Constr./draw.</i> JA/EAO	<i>Approved.</i>	<i>Scale.</i> 1:1	<i>Review nr.</i> Rev. 1
Utslåande ytterdør. Detalj under med HC terskel. Vertikalsnitt under, design trend			<i>Material.</i>	 Nordvestvinduet AS N-6713 ALMENNINGEN Tel +47 57 85 25 80 firmapost@nordvestvinduet.no www.nordvestvinduet.no
			<i>Replacement for:</i>	
<i>Tolerance.:</i> NS-ISO 2768-1-middels.			<i>Replaced of:</i>	



Date. 20.04.2014	Constr./draw. JA/EAO	Approved.	Scale. 1:1	Review nr. Rev. 1
Utslående ytterdør. Detalj over Vertikalsnitt over, design trend			Material.	 <small>Nordvestvinduet AS N-6713 ALMENNINGEN Tel +47 57 85 25 80 firmapost@nordvestvinduet.no www.nordvestvinduet.no</small>
Tolerance.: NS-ISO 2768-1-middels.			Replacement for:	Drawing nr. YU_TR_R115_O
			Replaced of:	

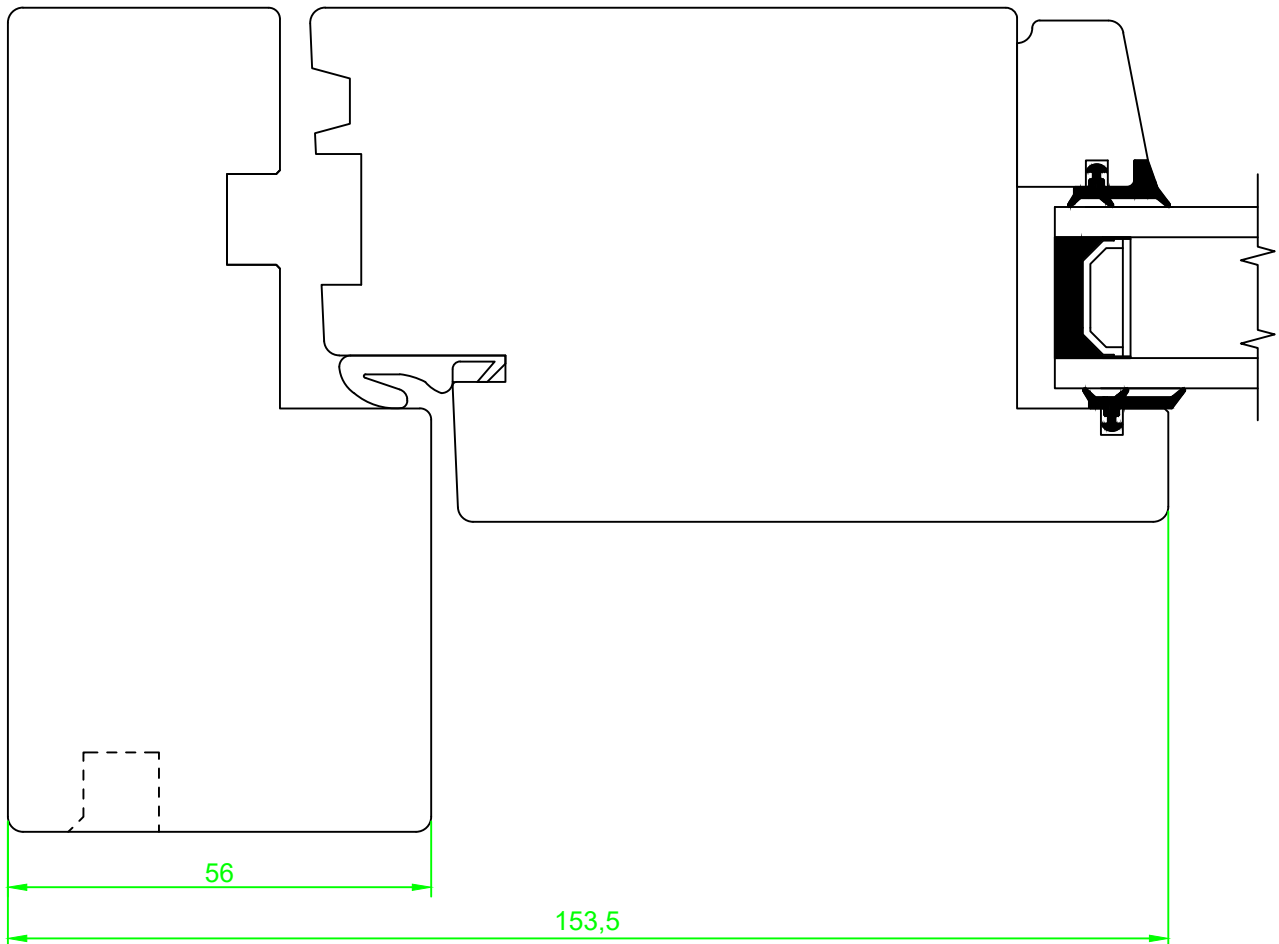

<i>Date.</i> 08.11.2010	<i>Constr./draw.</i> JA/EAO	<i>Approved.</i>	<i>Scale.</i> 1:1	<i>Review nr.</i> Rev. 1	
Utslående ytterdør. Detalj hengsleside. Vertikalsnitt under, design trend			<i>Material.</i>	 <small>Nordvestvinduet AS N-6713 ALMENNINGEN Tel +47 57 85 25 80 firmapost@nordvestvinduet.no www.nordvestvinduet.no</small>	
			<i>Replacement for:</i>		<i>Drawing nr.</i>
			<i>Replaced of:</i>		YU_TR_R115_HS
<i>Tolerance.: NS-ISO 2768-1-middels.</i>					

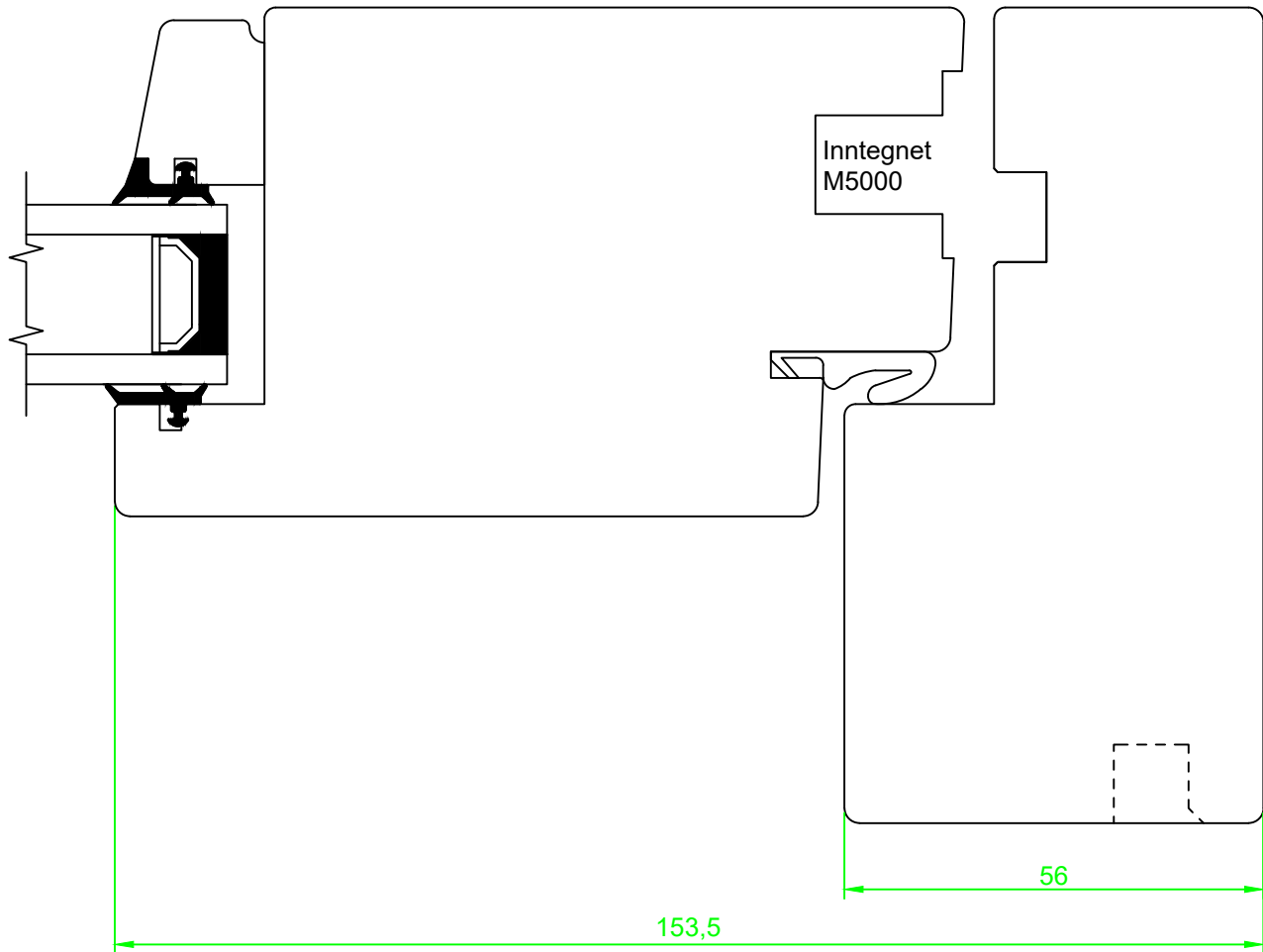

<i>Date.</i> 08.11.2010	<i>Constr./draw.</i> JA/EAO	<i>Approved.</i>	<i>Scale.</i> 1:1	<i>Review nr.</i> Rev. 1
Utslåande ytterdør. Detalj side. Vertikalsnitt under, design trend			<i>Material.</i>	 NORDVESTVINDUET <small>Nordvestvinduet AS N-6713 ALMENNINGEN Tel +47 57 85 25 80 firmapost@nordvestvinduet.no www.nordvestvinduet.no</small>
			<i>Replacement for:</i>	
<i>Tolerance.:</i> NS-ISO 2768-1-middels.			<i>Replaced of:</i>	

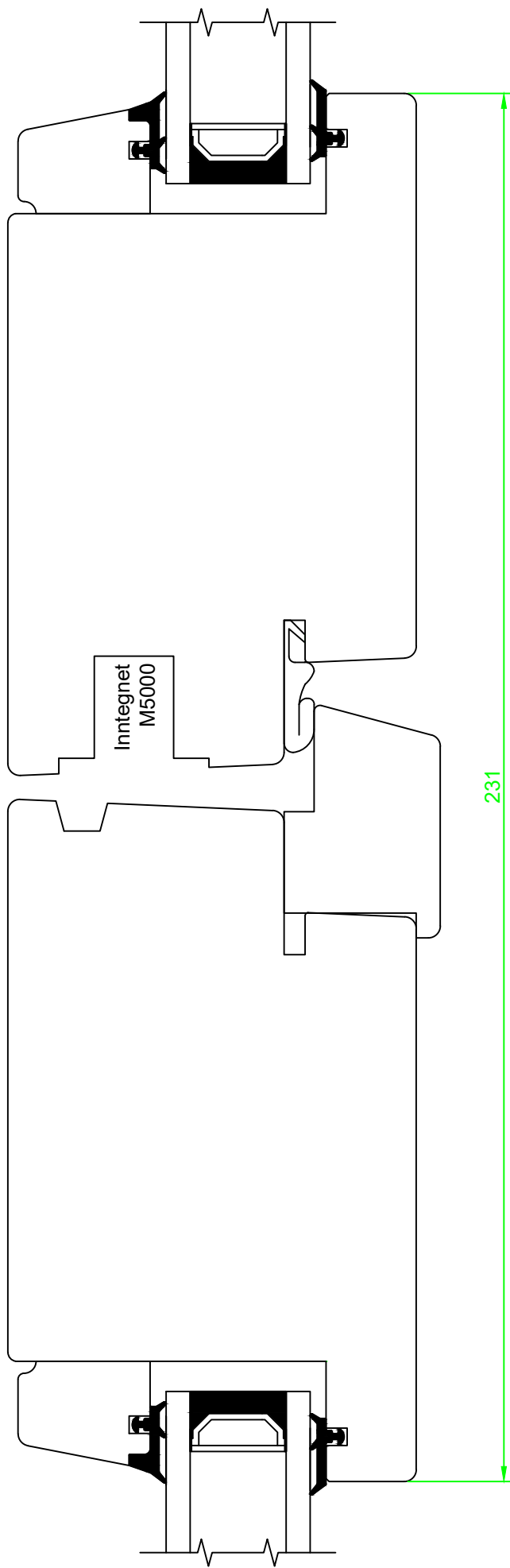

Date. 04.11.2013	Constr./draw. JA/EAO	Approved.	Scale. 1:1	Review nr. Rev. 1
Ytterdør utslående Detalj tofløya midt Horisontalsnitt, design Trend			Material.	<small>NOROVAVINDUET AS</small> <small>N-6713 ALMENNINGEN</small> <small>Tel +47 57 85 25 80</small> <small>firmapo@norovavinduet.no</small> <small>www.norovavinduet.no</small>
			Replacement for:	
Tolerance.: NS-ISO 2768-1-middels.			Replaced of:	

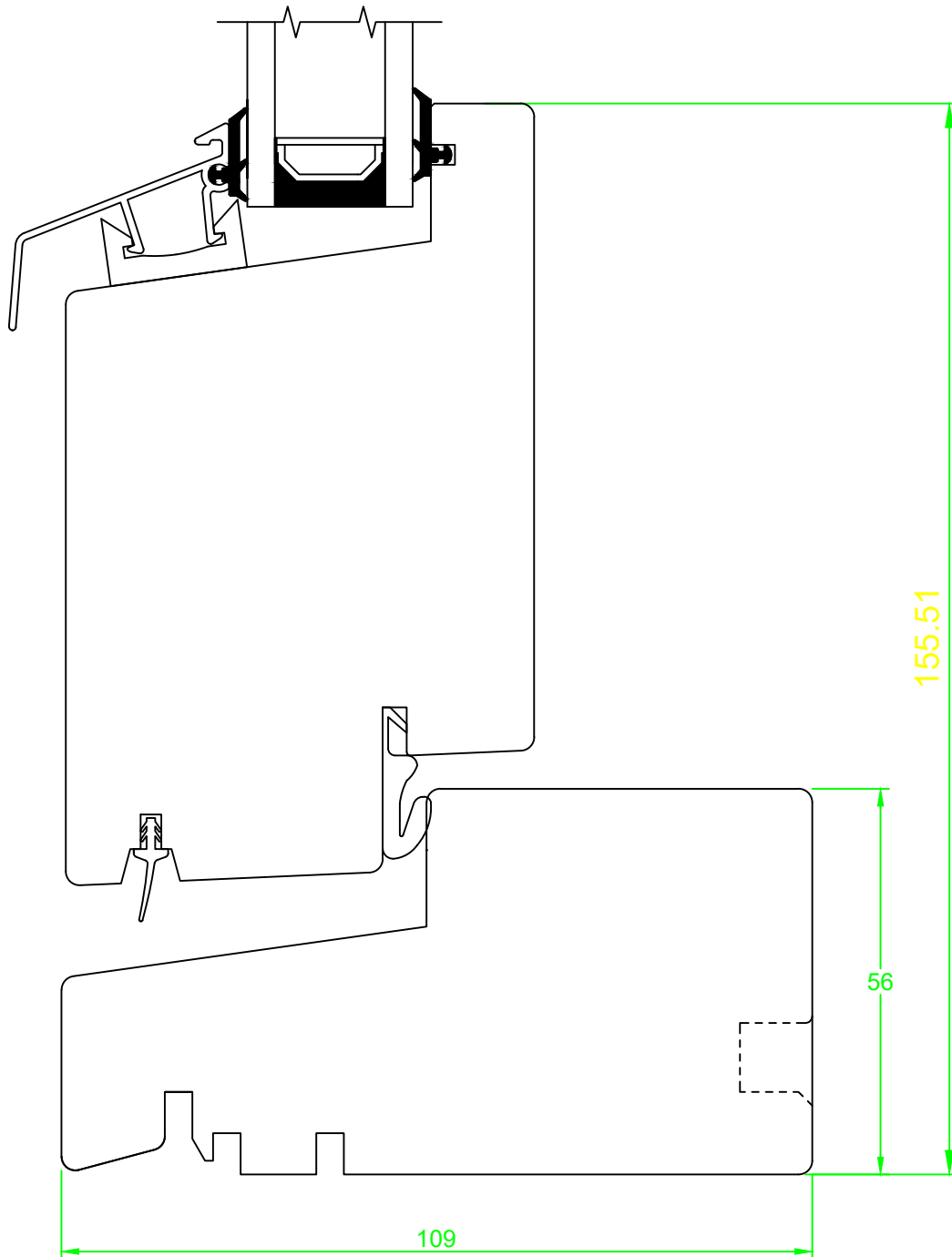

Date. 19.09.2013	Constr./draw. JA/EAO	Approved.	Scale. 1:1	Review nr. Rev. 1
Utslående ytterdør. Detalj under med hardvedterskel. Vertikalsnitt under, design trend			Material.	 Nordvestvinduet AS N-6713 ALMENNINGEN Tel +47 57 85 25 80 firmapost@nordvestvinduet.no www.nordvestvinduet.no
			Replacement for:	
Tolerance.: NS-ISO 2768-1-middels.			Replaced of:	YU_TR_R115_B

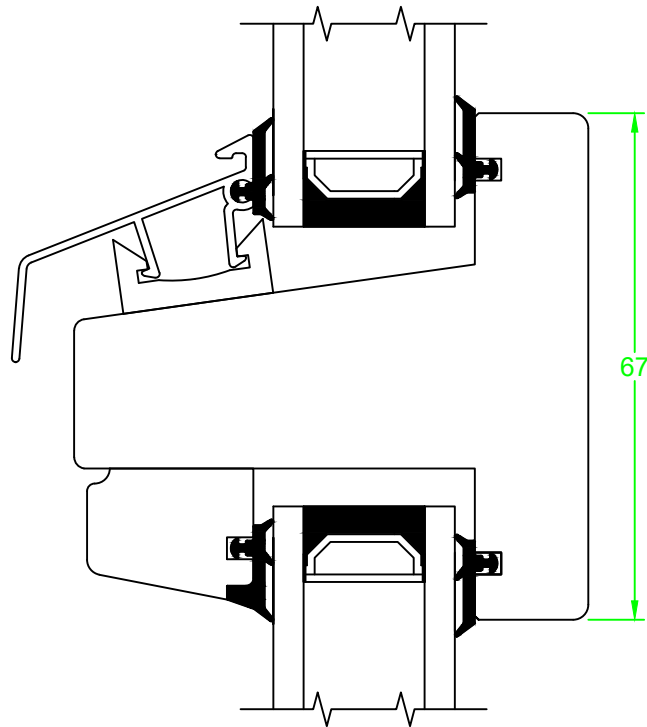

<i>Date.</i> 30.09.2010	<i>Constr./draw.</i> EAO	<i>Approved.</i>	<i>Scale.</i> 1:1	<i>Review nr.</i> Rev. 1
Sidehengslet vindu i tre Horizontal sprosse 67 mm Vertikalsnitt bunn, design trend			<i>Material.</i>	 <small>Nordvestvinduet AS N-6713 ALMENNINGEN Tel +47 57 85 25 80 firmapost@nordvestvinduet.no www.nordvestvinduet.no</small>
			<i>Replacement for:</i>	
<i>Tolerance.:</i> NS-ISO 2768-1-middels.			<i>Replaced of:</i>	