

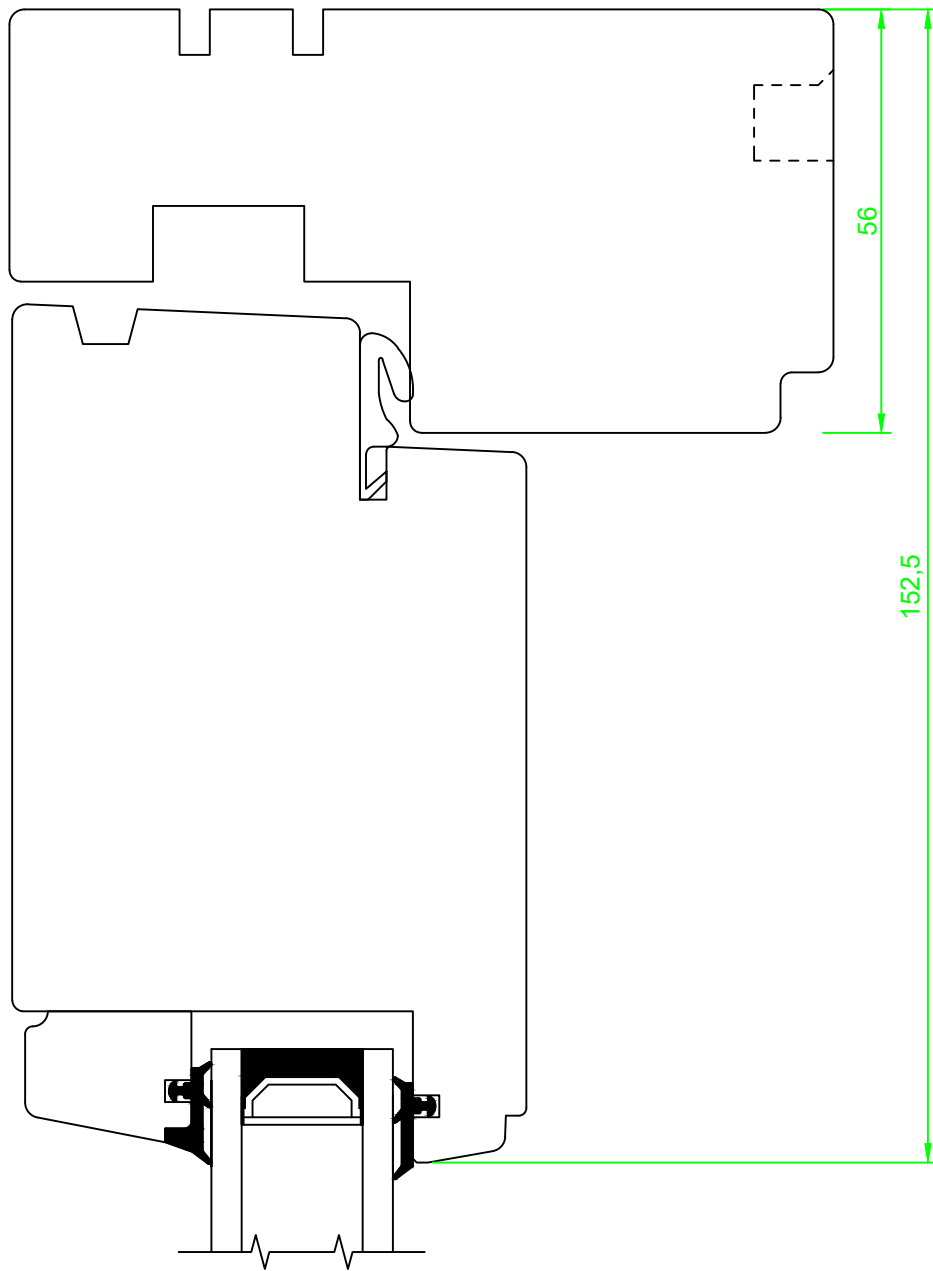



<i>Date.</i> 22.5.2013	<i>Constr./draw.</i> JA/EAO	<i>Approved.</i>	<i>Scale.</i> 1:1	<i>Review nr.</i> Rev. 1
Utslående ytterdør. Detalj under med HC terskel. Vertikalsnitt under, design standard			<i>Material.</i>	 Nordvestvinduet AS N-6713 ALMENNINGEN Tel +47 57 85 25 80 firmapost@nordvestvinduet.no www.nordvestvinduet.no
			<i>Replacement for:</i>	
			<i>Tolerance.:</i> NS-ISO 2768-1-middels.	<i>Replaced of:</i>



<i>Date.</i> 20.04.2014	<i>Constr./draw.</i> JA/EAO	<i>Approved.</i>	<i>Scale.</i> 1:1	<i>Review nr.</i> Rev. 1
Utslåande ytterdør. Detalj over Vertikalsnitt over, design standard			<i>Material.</i>	 Nordvestvinduet AS N-6713 ALMENNINGEN Tel +47 57 85 25 80 firmapost@nordvestvinduet.no www.nordvestvinduet.no
			<i>Replacement for:</i>	
<i>Tolerance.: NS-ISO 2768-1-middels.</i>			<i>Replaced of:</i>	

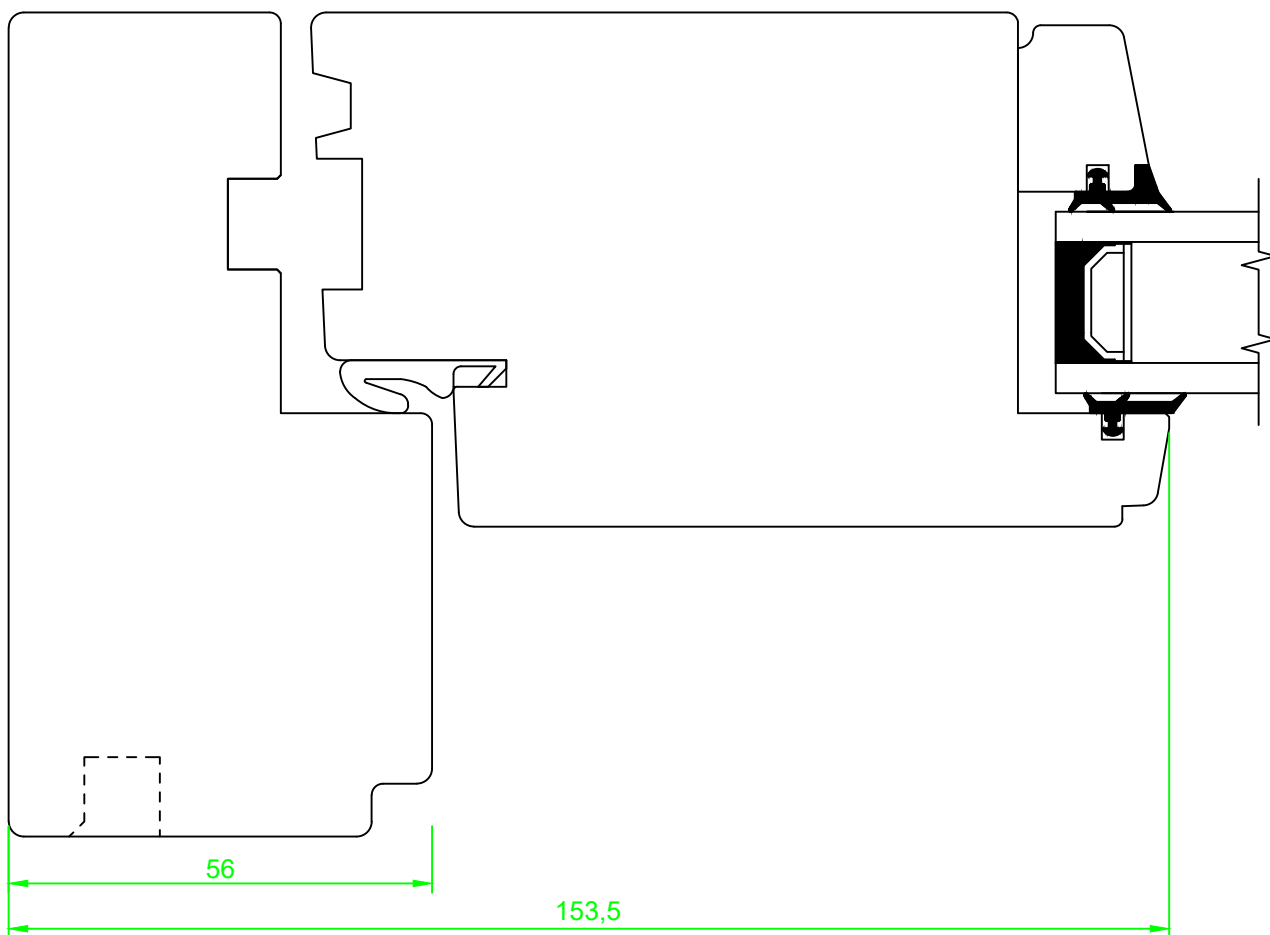

<i>Date.</i> 08.11.2010	<i>Constr./draw.</i> JA/EAO	<i>Approved.</i>	<i>Scale.</i> 1:1	<i>Review nr.</i> Rev. 1
Utslåande ytterdør. Detalj hengleside. Vertikalsnitt under, design standard			<i>Material.</i>	 NORDVESTVINDUET <small>Nordvestvinduet AS N-6713 ALMENNINGEN Tel +47 57 85 23 80 firmapost@nordvestvinduet.no www.nordvestvinduet.no</small>
			<i>Replacement for:</i>	
<i>Tolerance.:</i> NS-ISO 2768-1-middels.			<i>Replaced of:</i>	

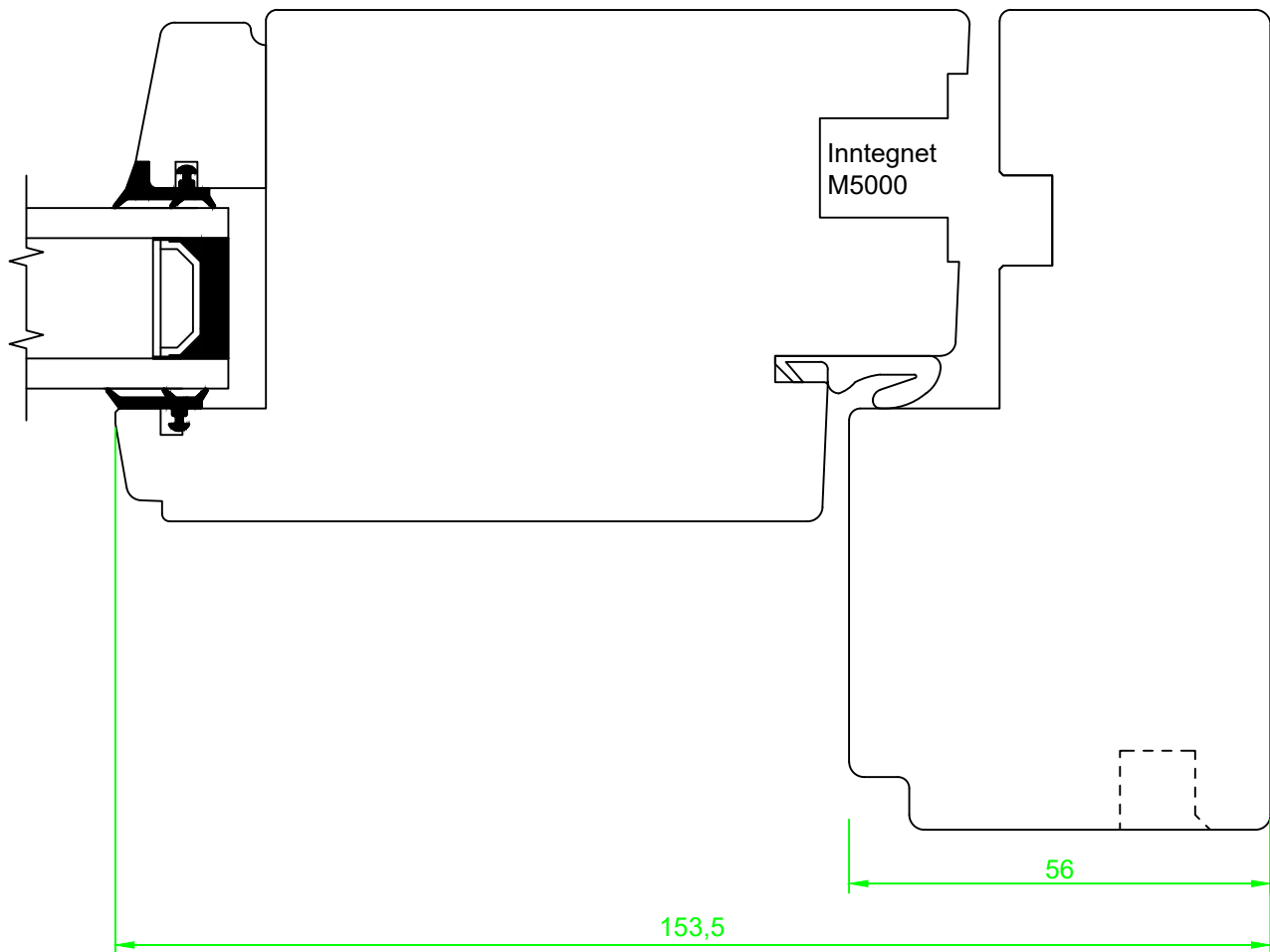

Date. 08.11.2010	Constr./draw. JA/EAO	Approved.	Scale. 1:1	Review nr. Rev. 1
Utslåande ytterdør. Detalj side. Vertikalsnitt under, design standard			Material.	 Nordvestvinduet AS N-6713 ALMENNINGEN Tel: +47 57 85 25 80 firmapost@nordvestvinduet.no www.nordvestvinduet.no
			Replacement for:	
Tolerance.: NS-ISO 2768-1-middels.			Replaced of:	

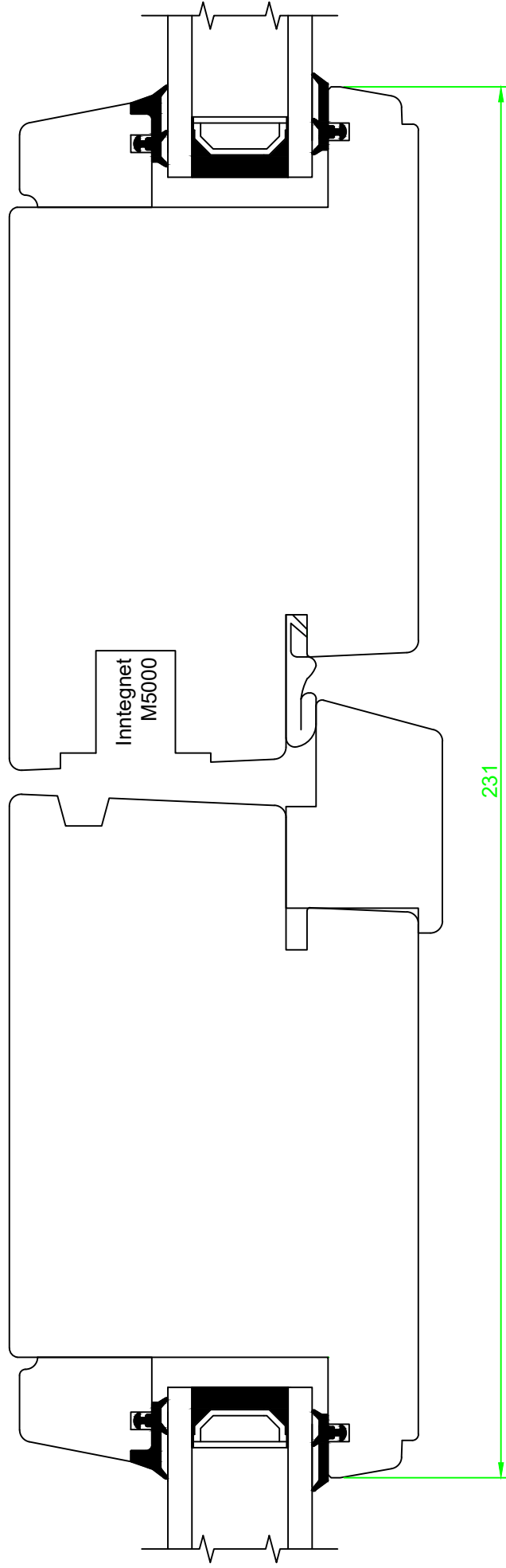

Date.	04.11.2013	Constr./draw.	JA/EAO	Approved.	Scale.	1:1	Review nr.	Rev. 1	
Ytterdør utslående					Material.		<small>NORVESTVIND ET AS N:8713 ALMENNINGEN Tlf: +47 57 85 25 80 firmapost@norvestvindret.no www.norvestvindret.no</small>		
Detalj tofløya midt					Replacement for:	Drawing nr.			
Horisontalsnitt, design standard					Replaced of:	YU_ST_R115_2FL			
Tolerance.: NS-ISO 2768-1-middels.									

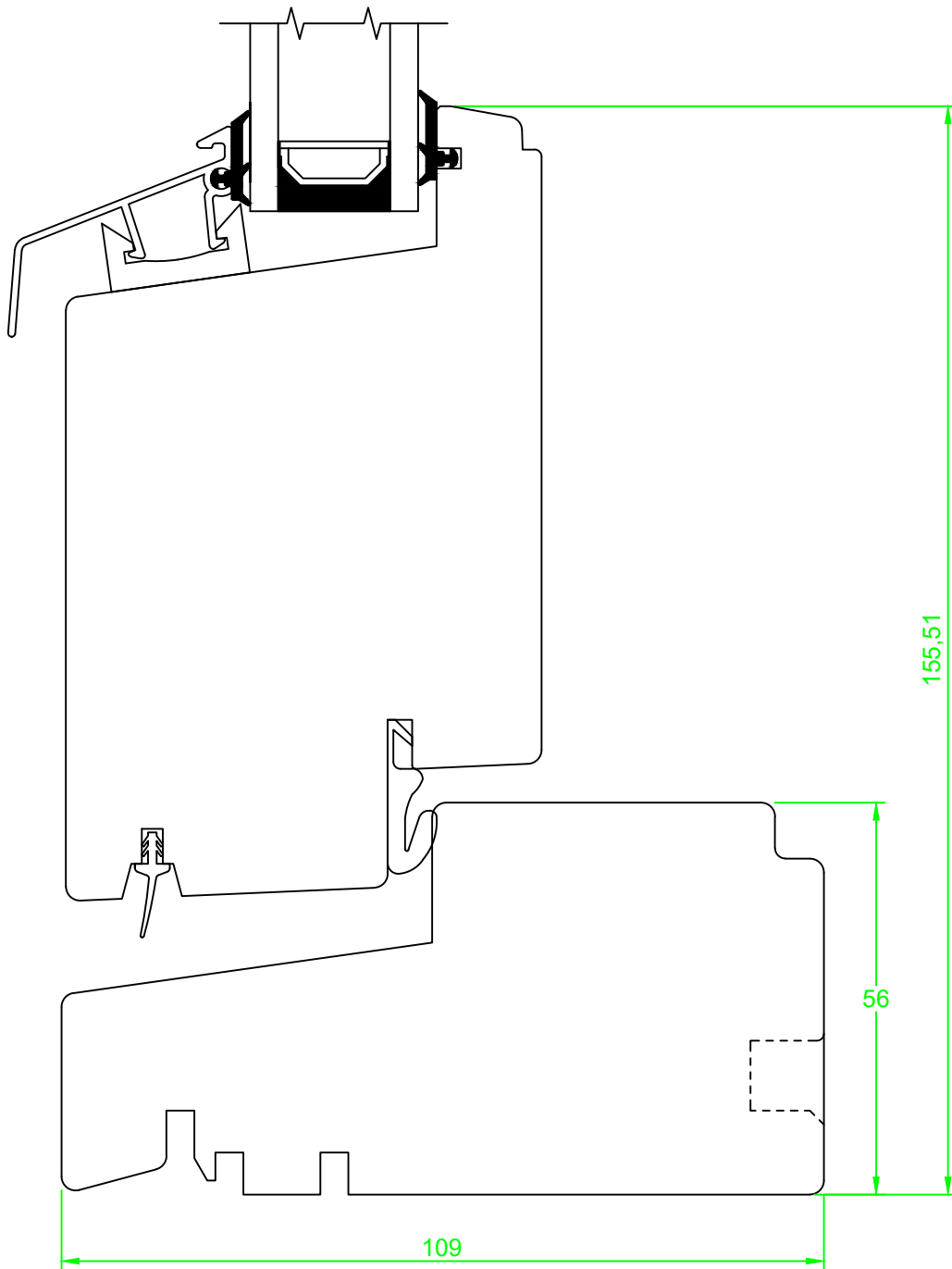

<i>Date.</i> 19.09.2013	<i>Constr./draw.</i> JA/EAO	<i>Approved.</i>	<i>Scale.</i> 1:1	<i>Review nr.</i> Rev. 1
Utslåande ytterdør. Detalj under med hardvedterskel. Vertikalsnitt under, design standard			<i>Material.</i>	 Nordvestvinduet AS N-6713 ALMENNINGEN Tel +47 57 85 25 80 firmapost@nordvestvinduet.no www.nordvestvinduet.no
			<i>Replacement for:</i>	
<i>Tolerance.: NS-ISO 2768-1-middels.</i>			<i>Replaced of:</i>	

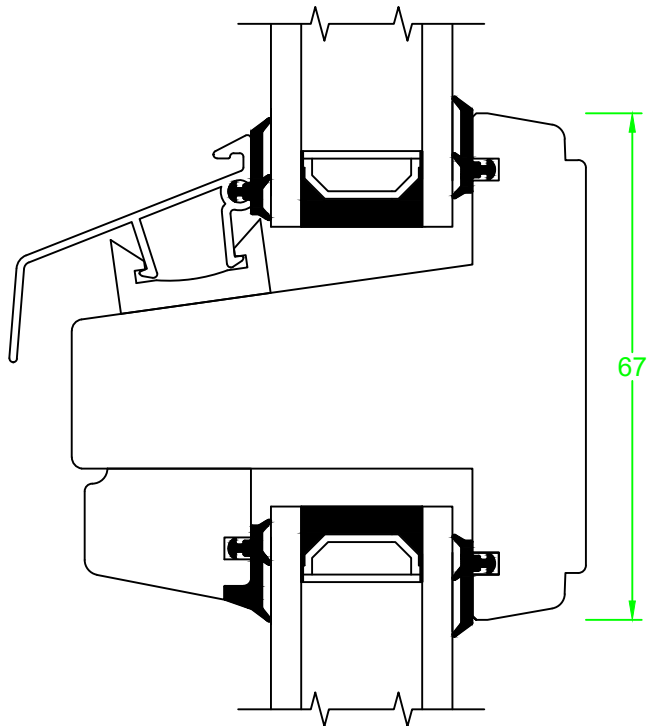

<i>Date.</i> 30.09.2010	<i>Constr./draw.</i> EAO	<i>Approved.</i>	<i>Scale.</i> 1:1	<i>Review nr.</i> Rev. 1
Sidehengslet vindu i tre Horizontal sprosse 67 mm Vertikalsnitt bunn, design trend			<i>Material.</i>	 <small>Nordvestvinduet AS N-6713 ALMENNINGEN Tel: +47 57 85 25 80 firmapost@nordvestvinduet.no www.nordvestvinduet.no</small>
			<i>Replacement for:</i>	
			<i>Tolerance.:</i> NS-ISO 2768-1-middels.	<i>Replaced of:</i>