

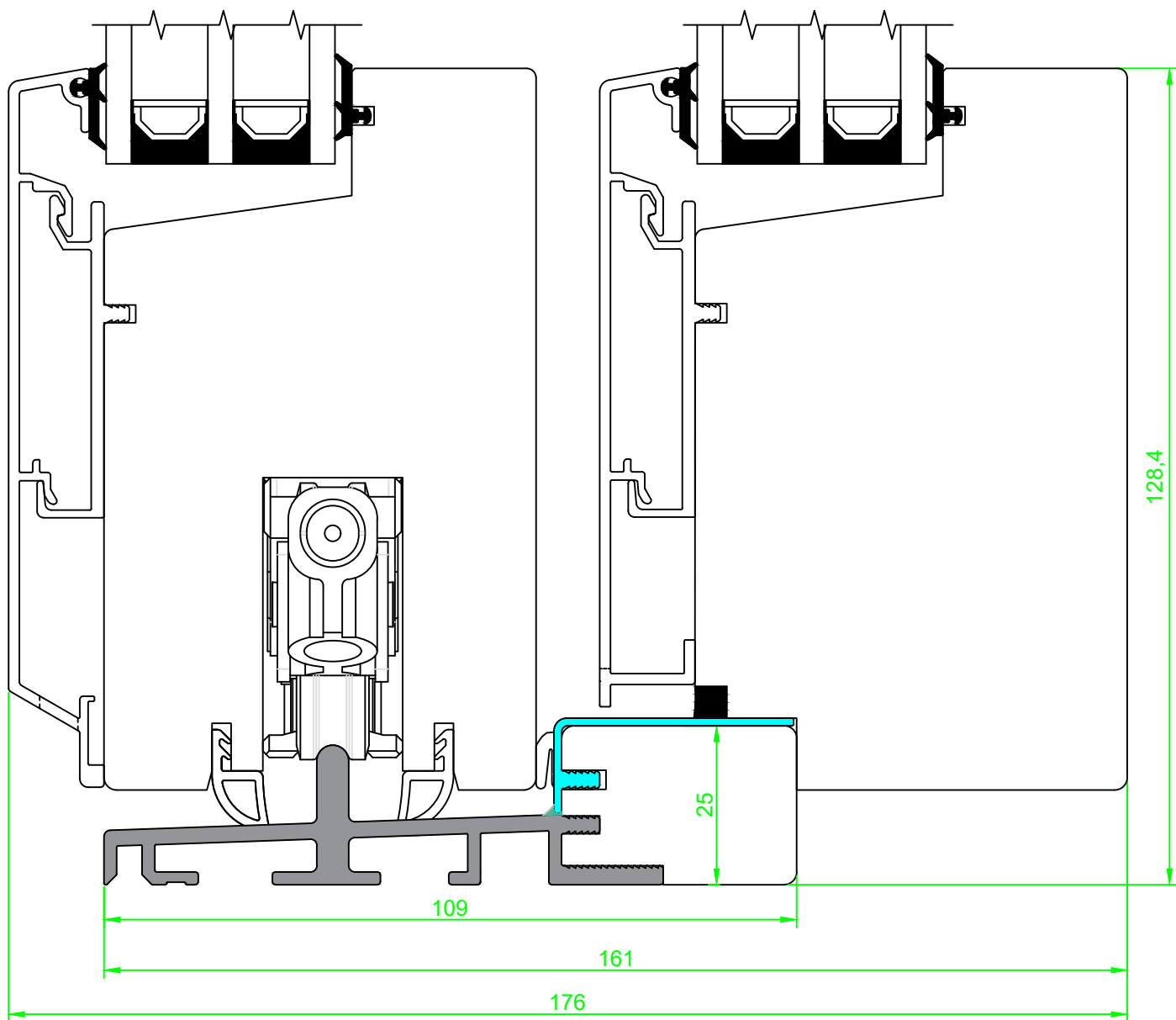



<i>Date.</i> 16.09.2016	<i>Constr./draw.</i> EAO/CO	<i>Approved.</i>	<i>Scale.</i> 1:1	<i>Review nr.</i> Rev. 2
Hev og senk skyvedør med GU beslag Glass 36mm Vertikalsnitt, detalj Bunn hardvedterskel <i>Tolerance.: NS-ISO 2768-1-middels.</i>			<i>Material.</i>	 Nordvestvinduet AS N-6713 ALMENNINGEN Tel +47 57 85 25 80 firmapost@nordvestvinduet.no www.nordvestvinduet.no
			<i>Replacement for:</i>	
			<i>Replaced of:</i>	SDA39_TR_B



Date. 16.09.2016	Constr./draw. EAO/CO	Approved.	Scale. 1:1	Review nr. Rev. 2
Hev og senk skyvedør med GU beslag Glass 36mm Vertikalsnitt, detalj Bunn HC-terskel			Material.	 Nordvestvinduet AS N-6713 ALMENNENGEN Tel +47 57 85 25 80 firmapost@nordvestvinduet.no www.nordvestvinduet.no
			Replacement for:	
Tolerance.: NS-ISO 2768-1-middels.			Replaced of:	SDA39_TR_B_HC

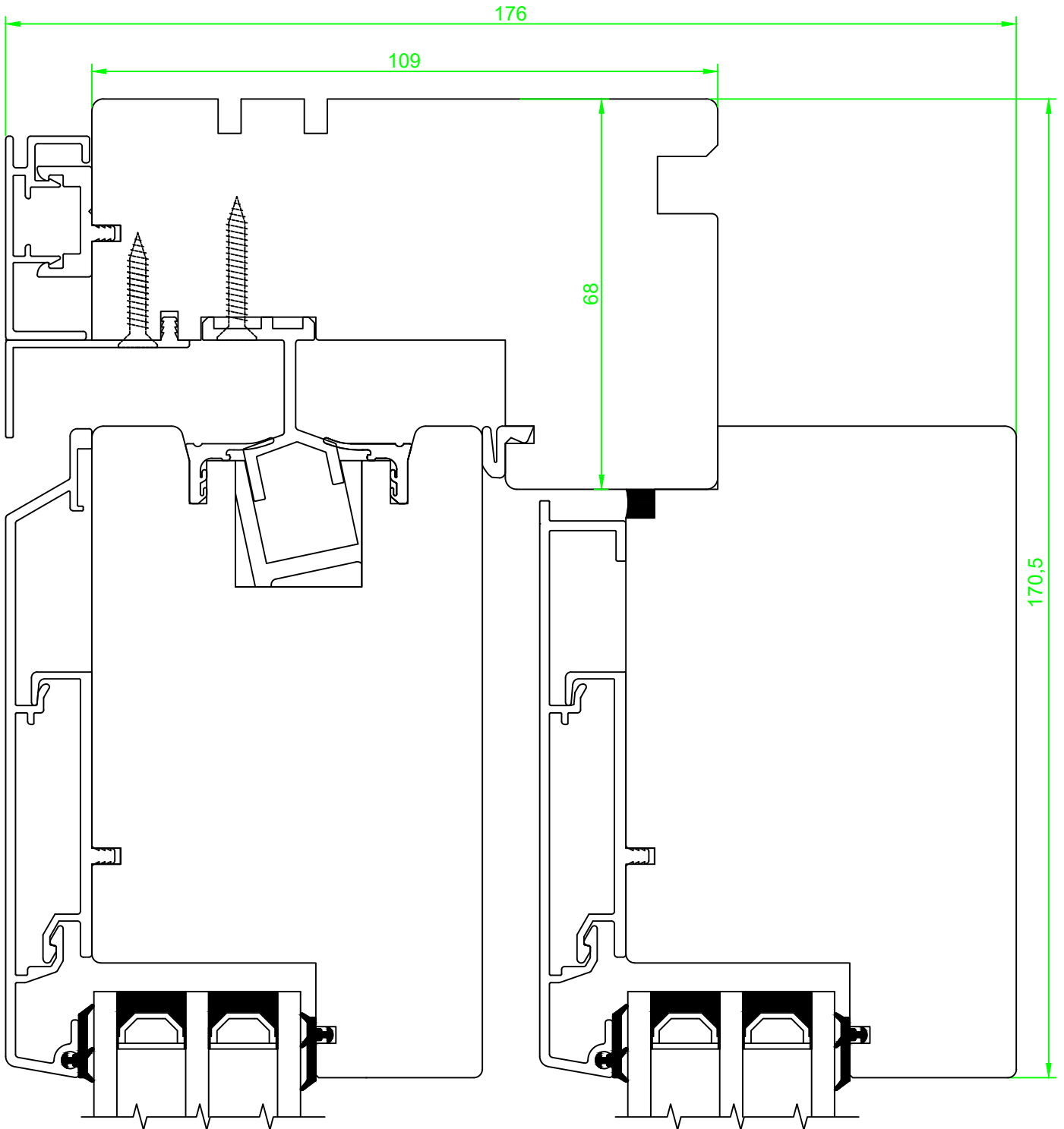

<i>Date.</i> 16.09.2016	<i>Constr./draw.</i> EAO/CO	<i>Approved.</i>	<i>Scale.</i> 1:1	<i>Review nr.</i> Rev. 2
Hev og senk skyvedør med GU beslag Glass 36mm Vertikalsnitt, detalj topp			<i>Material.</i>	 Nordvestvinduet AS N-6713 ALMENNINGEN Tel +47 57 85 25 80 firmapost@nordvestvinduet.no www.nordvestvinduet.no
			<i>Replacement for:</i>	
<i>Tolerance.:</i> NS-ISO 2768-1-middels.			<i>Replaced of:</i>	

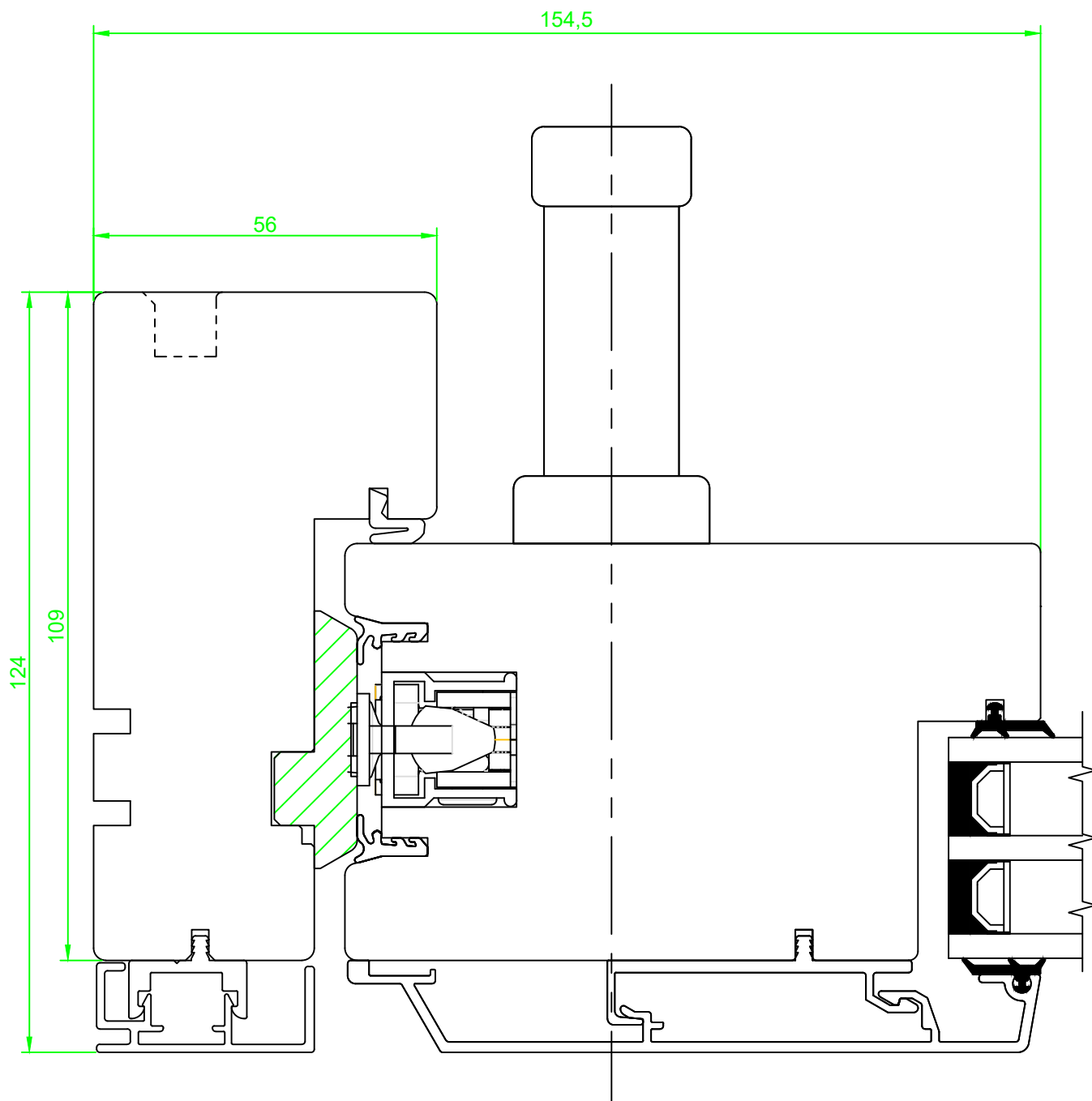

<i>Date.</i> 16.09.2016	<i>Constr./draw.</i> EAO/CO	<i>Approved.</i>	<i>Scale.</i> 1:1	<i>Review nr.</i> Rev. 2
Hev og senk skyvedør med GU beslag Glass 36mm Horizontalsnitt, detalj låsside			<i>Material.</i>	 Nordvestvinduet AS N-6713 ALMENNINGEN Tel +47 57 85 25 80 firmapost@nordvestvinduet.no www.nordvestvinduet.no
			<i>Replacement for:</i>	
<i>Tolerance.:</i> NS-ISO 2768-1-middels.			<i>Replaced of:</i>	

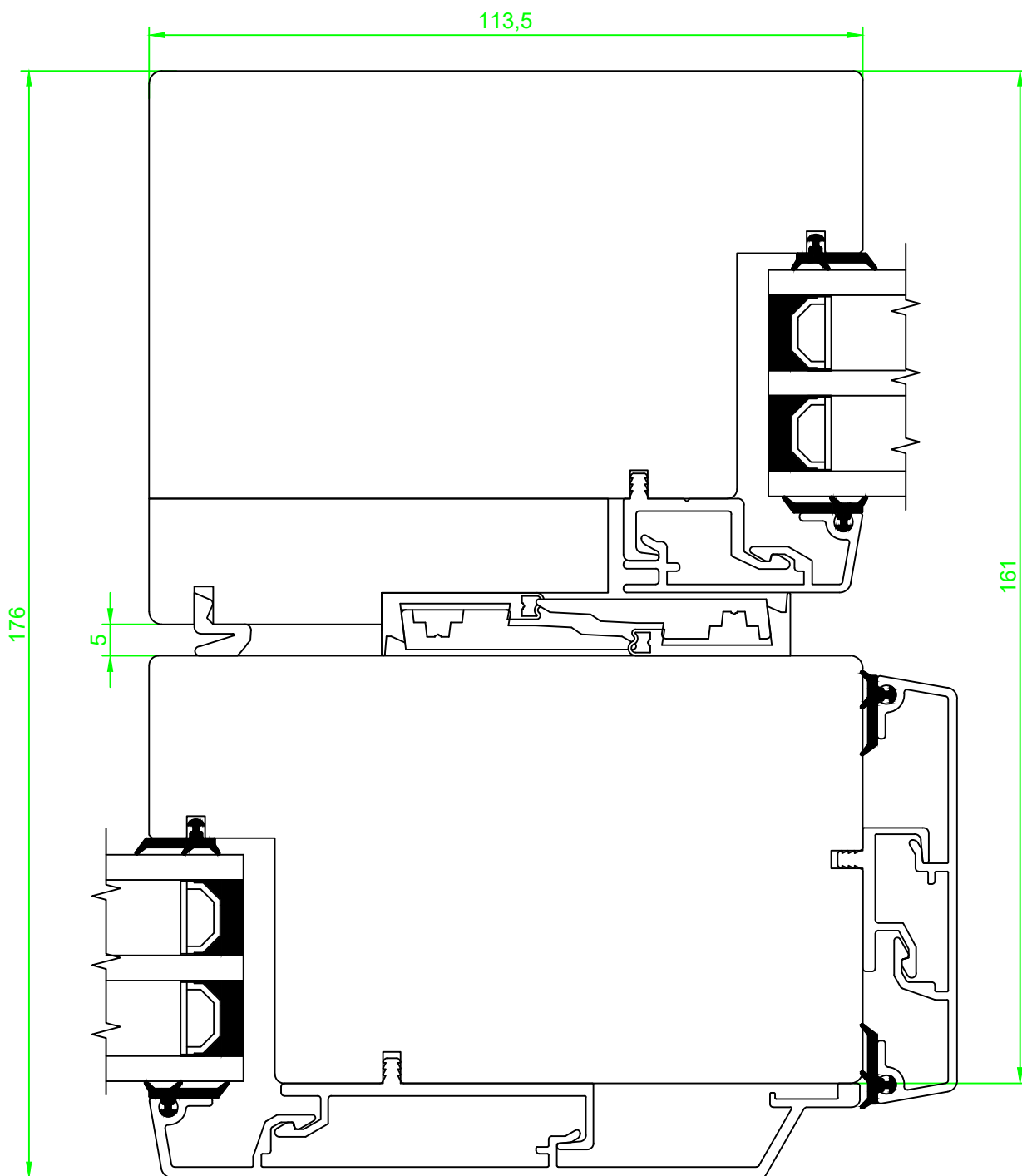

Date. 16.09.2016	Constr./draw. RS/EAO	Approved.	Scale. 1:1	Review nr. Rev. 2
Hev og senk skyvedør med GU beslag Glass 36mm Horizontalsnitt, detalj midt			Material.	 Nordvestvinduet AS N-6713 ALMENNINGEN Tel +47 57 85 25 80 firmapost@nordvestvinduet.no www.nordvestvinduet.no
			Replacement for:	
Tolerance.: NS-ISO 2768-1-middels.			Replaced of:	

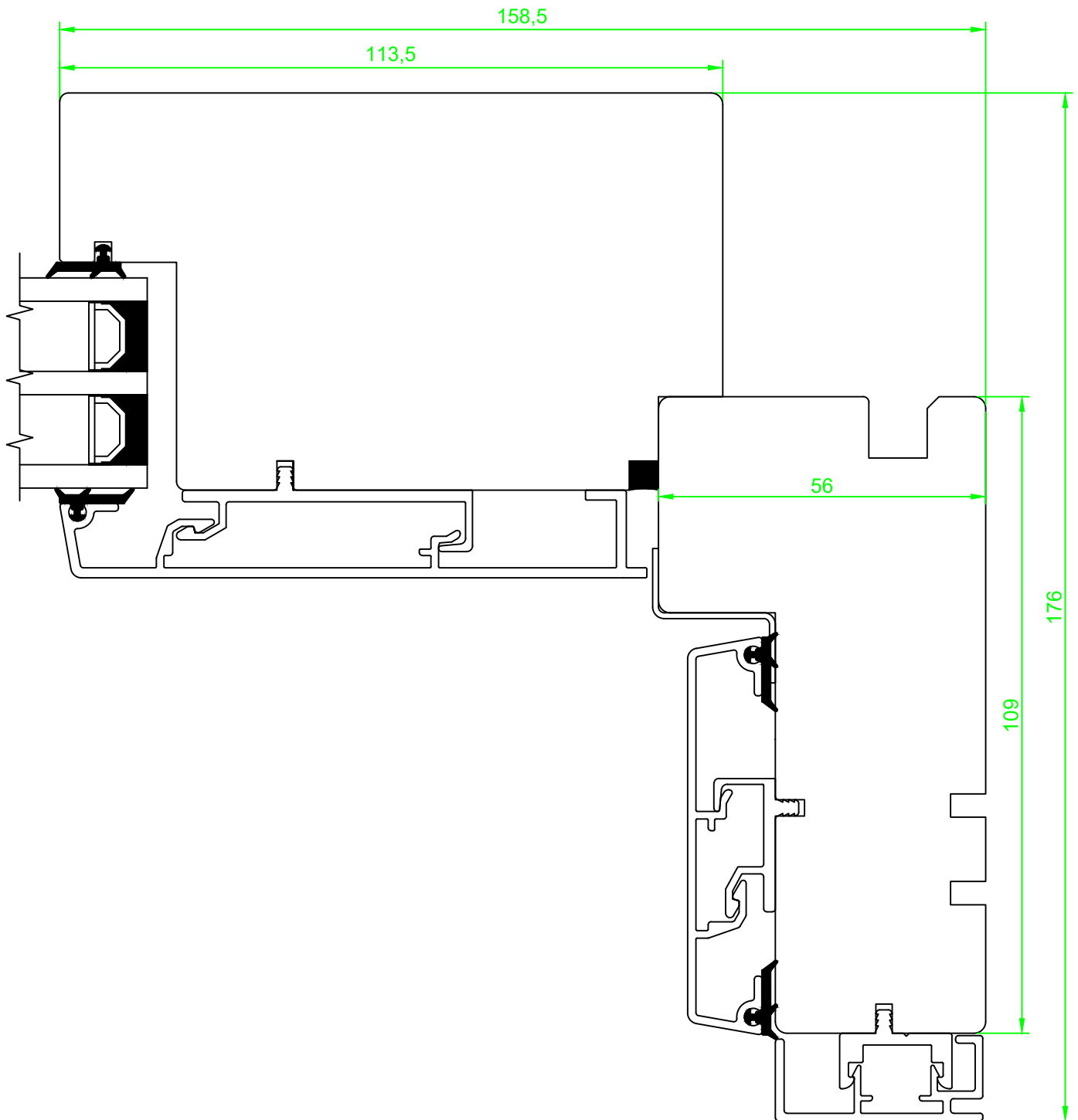

<i>Date.</i> 16.09.2016	<i>Constr./draw.</i> EAO/CO	<i>Approved.</i>	<i>Scale.</i> 1:1	<i>Review nr.</i> Rev. 2
Høv og senk skyvedør med GU beslag Glass 36mm Horizontalsnitt, detalj fastfeltside			<i>Material.</i>	 Nordvestvinduet AS N-6713 ALMENNINGEN Tel +47 57 85 25 80 firmapost@nordvestvinduet.no www.nordvestvinduet.no
			<i>Replacement for:</i>	
<i>Tolerance.:</i> NS-ISO 2768-1-middels.			<i>Replaced of:</i>	

219

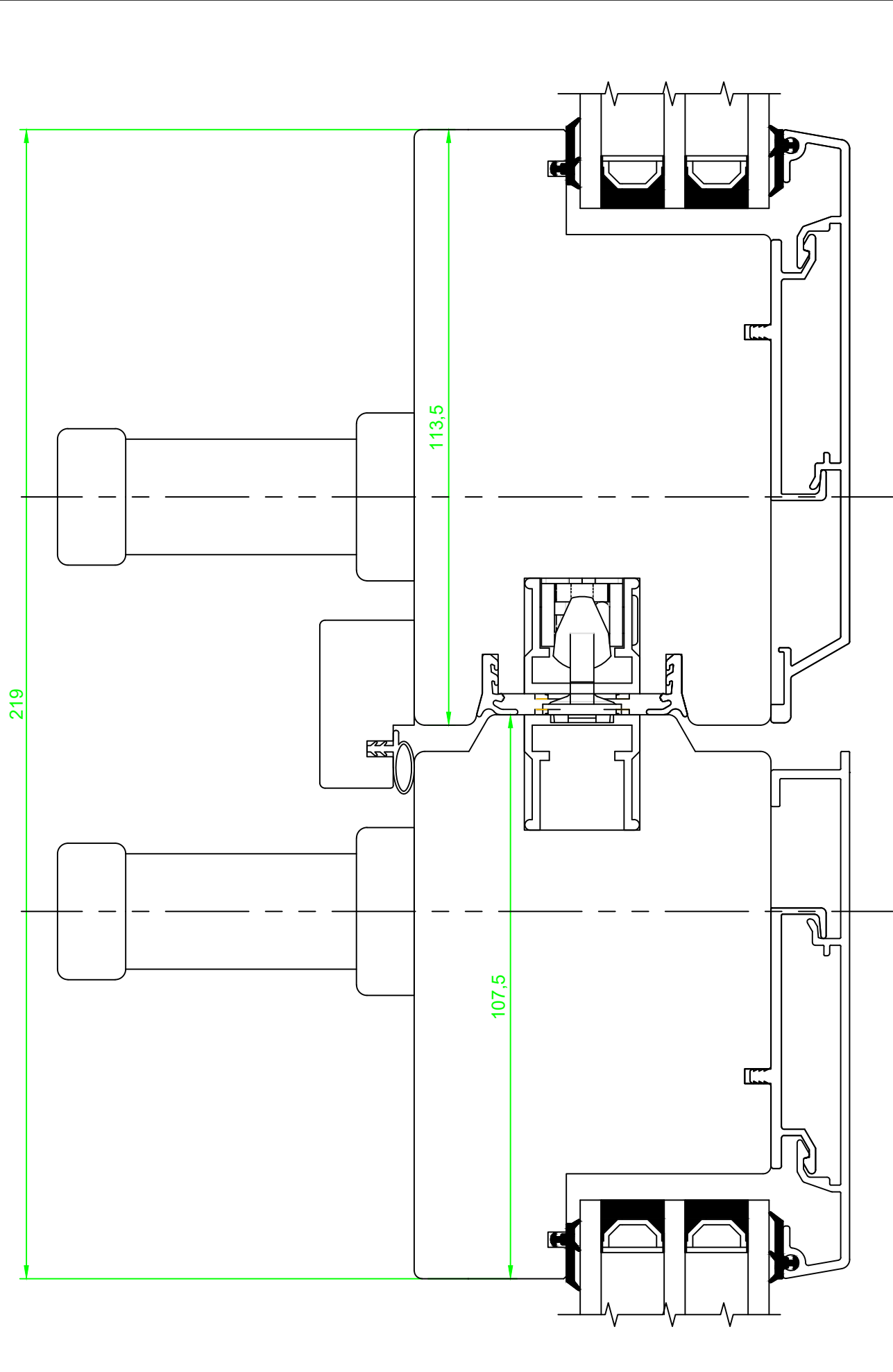

113,5

107,5

Dato:	16.09.2016	Konstr./Tegnet:	EAO/CO	Godkjent:		Ref. nr.:	Rev. 2
Hev og senk skyvedør med GU beslag							
Glass 36mm							
Horizontalsnit, detalj i midt SD4							
Tegnning nr. SDA39_TR_SD4							
Erstatlet av:							
Målestokk:							
Materiale:							
Tolkelse: NS-ISO 2768-T-middels							

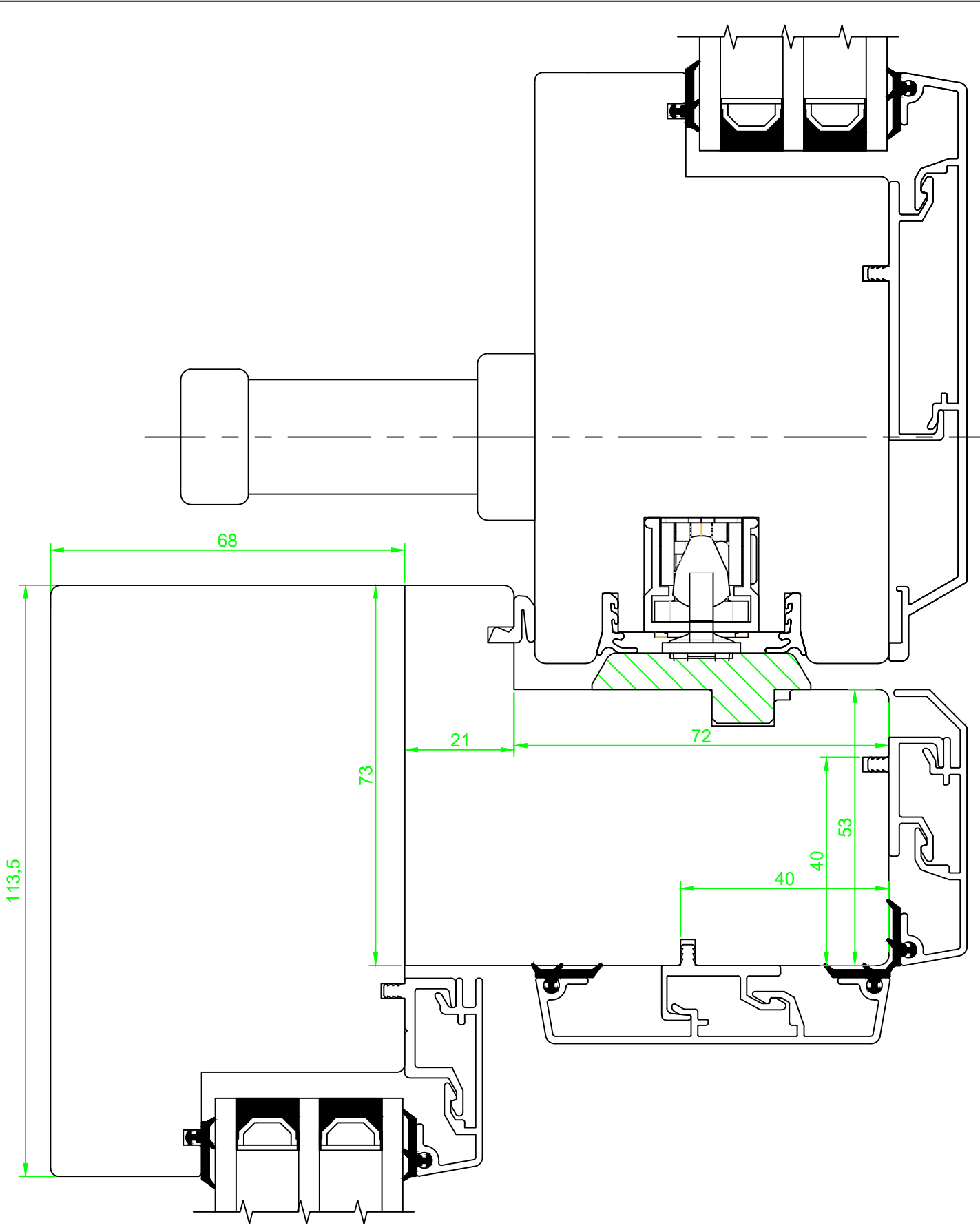

<i>Dato.</i> 16.09.2016	<i>Konstr./Tegnet.</i> EAO/CO	<i>Godkjent.</i>	<i>Målestokk.</i> 1:1	<i>Ref. nr.</i> Rev. 2	
Skyvedørpost SDTA3 Glass 36mm Horizontalsnitt			<i>Materiale.</i>	<small>Nordvestvinduet AS N-6713 ALMENNINGEN T 57 85 25 80 firmapost@nordvestvinduet.no www.nordvestvinduet.no</small>	
			<i>Erstatning for:</i>		<i>Tegning nr.</i>
			<i>Erstattet av:</i>		SD3A39_TR_P
<i>Toleranse.: NS-ISO 2768-1-middels.</i>					