

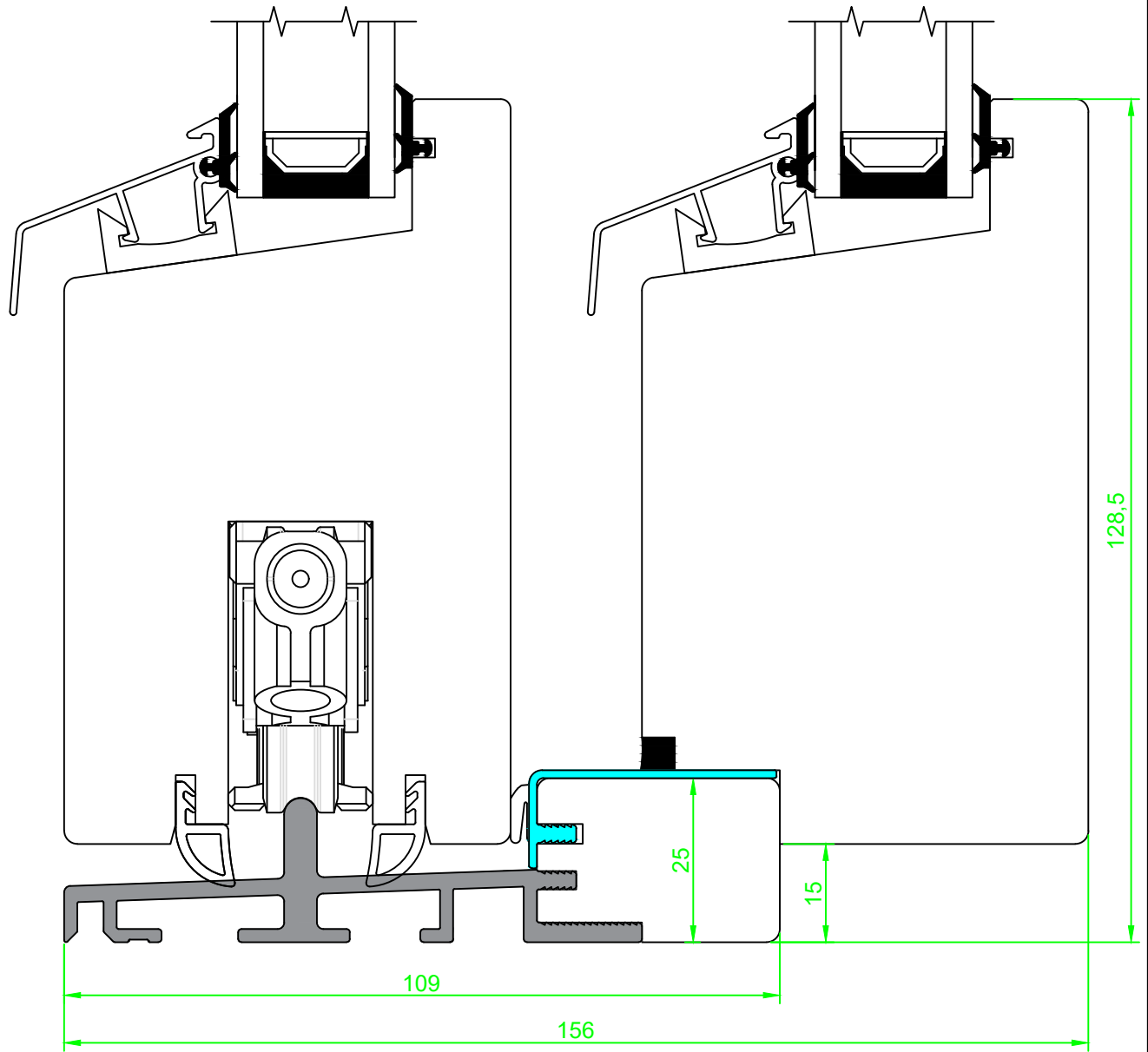



Date. 13.03.2017	Constr./draw. EAO	Approved.	Scale. 1:1	Review nr. Rev. 2
Hev og senk skyvedør med GU beslag Vertikalsnitt, detalj Bunn hardvedterskel			Material.	 Nordvestvinduet AS N-6713 ALMENNINGEN Tel +47 57 85 25 80 firmapost@nordvestvinduet.no www.nordvestvinduet.no
			Replacement for:	
Tolerance.: NS-ISO 2768-1-middels.			Replaced of:	



<i>Date.</i> 13.03.2017	<i>Constr./draw.</i> EAO	<i>Approved.</i>	<i>Scale.</i> 1:1	<i>Review nr.</i> Rev. 2
Hev og senk skyvedør med GU beslag Vertikalsnitt, detalj Bunn HC-terskel			<i>Material.</i>	 Nordvestvinduet AS N-6713 ALMENNINGEN Tel +47 57 85 25 80 firmapost@nordvestvinduet.no www.nordvestvinduet.no
			<i>Replacement for:</i>	
<i>Tolerance.: NS-ISO 2768-1-middels.</i>			<i>Replaced of:</i>	SD_TR_B_HC

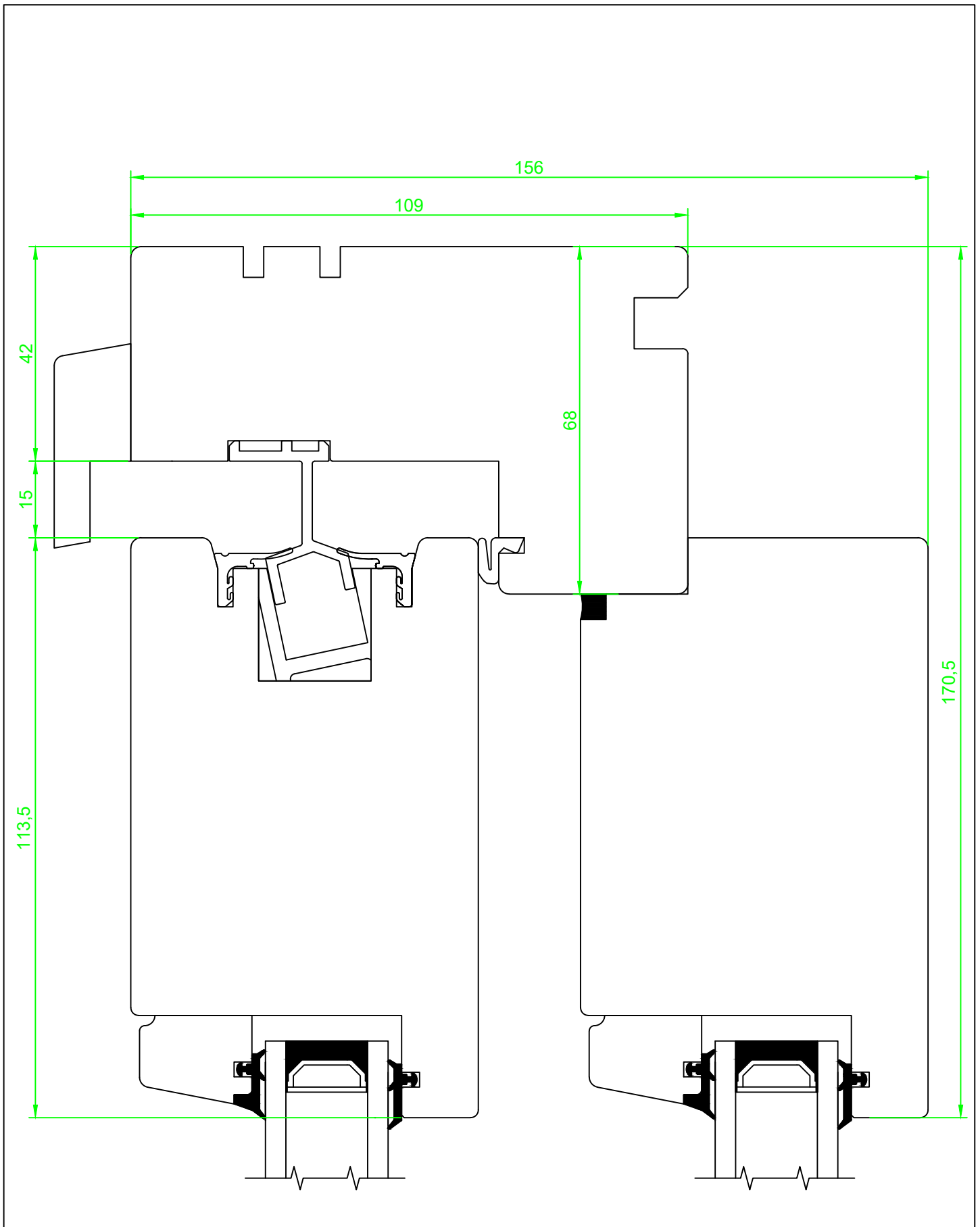

<i>Date.</i> 13.03.2017	<i>Constr./draw.</i> EAO	<i>Approved.</i>	<i>Scale.</i> 1:1	<i>Review nr.</i> Rev. 2
Hev og senk skyvedør med GU beslag  Vertikalsnitt, detalj topp			<i>Material.</i>	 Nordvestvinduet AS N-6713 ALMENNINGEN Tel +47 57 85 25 80 firmapost@nordvestvinduet.no www.nordvestvinduet.no
			<i>Replacement for:</i>	
<i>Tolerance.: NS-ISO 2768-1-middels.</i>			<i>Replaced of:</i>	

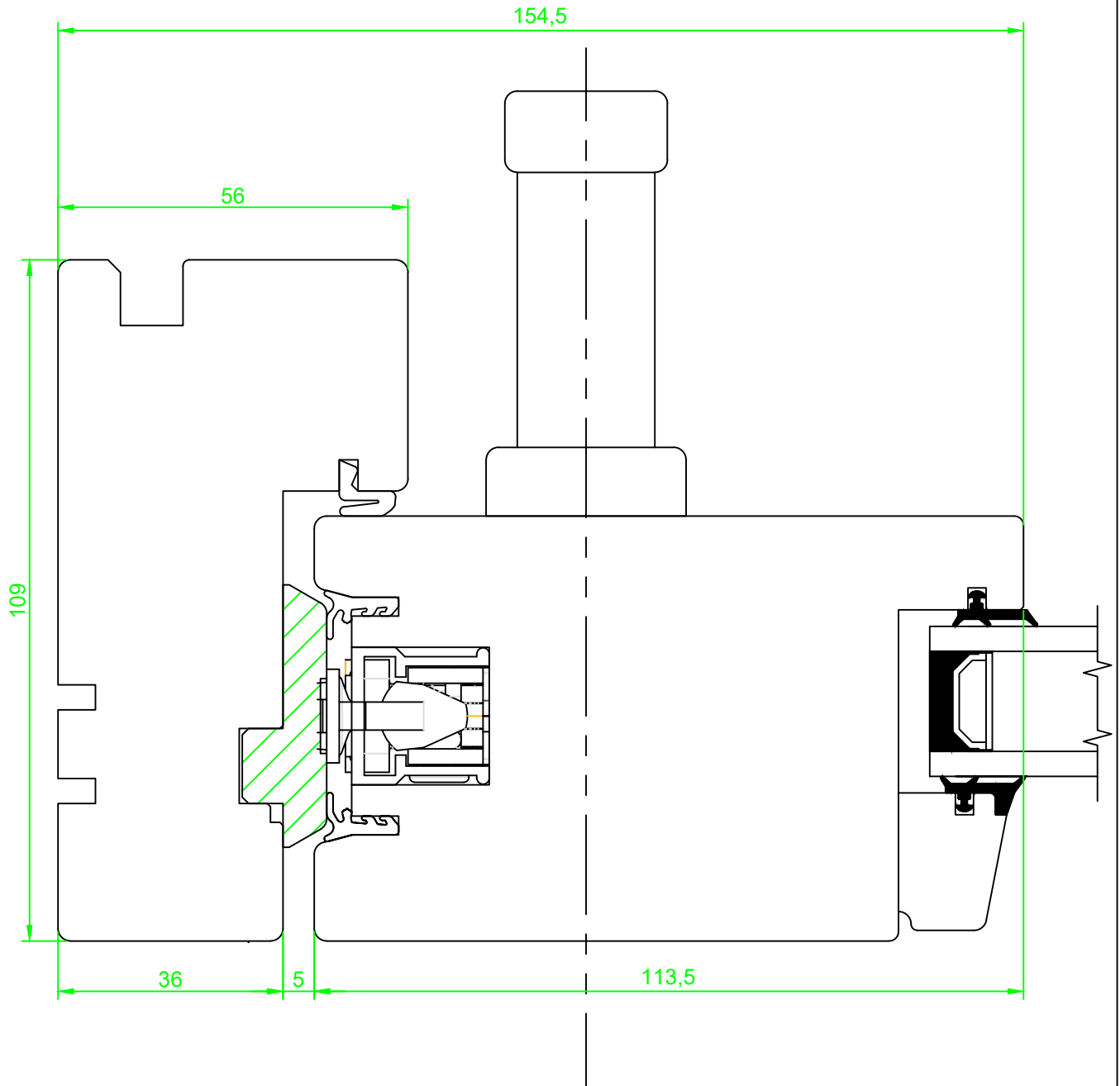

<i>Date.</i> 13.01.2015	<i>Constr./draw.</i> EAO	<i>Approved.</i>	<i>Scale.</i> 1:1	<i>Review nr.</i> Rev. 2
Hev og senk skyvedør med GU beslag  Horisontalsnitt, detalj låsside			<i>Material.</i>	 <small>Nordvestvinduet AS N-6713 ALMENNINGEN Tel +47 57 85 25 80 firmapost@nordvestvinduet.no www.nordvestvinduet.no</small>
			<i>Replacement for:</i>	
<i>Tolerance.:</i> NS-ISO 2768-1-middels.			<i>Replaced of:</i>	

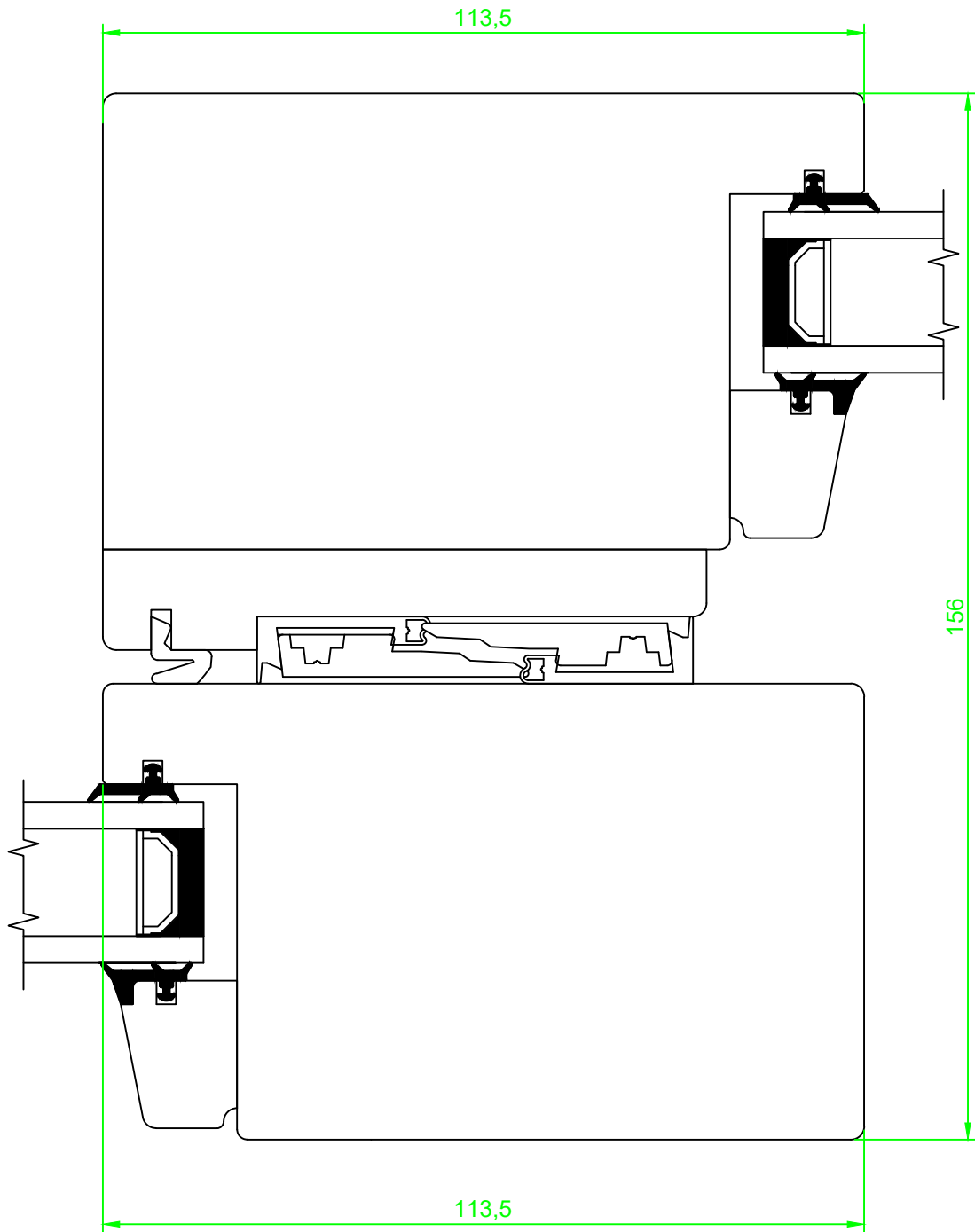

<i>Date.</i> 13.03.2017	<i>Constr./draw.</i> RS/EAO	<i>Approved.</i>	<i>Scale.</i> 1:1	<i>Review nr.</i> Rev. 2
Hev og senk skyvedør med GU beslag  Horizontalsnitt, detalj midt			<i>Material.</i>	 Nordvestvinduet AS N-6713 ALMENNINGEN Tel +47 57 85 25 80 firmapost@nordvestvinduet.no www.nordvestvinduet.no
			<i>Replacement for:</i>	
<i>Tolerance.: NS-ISO 2768-1-middels.</i>			<i>Replaced of:</i>	

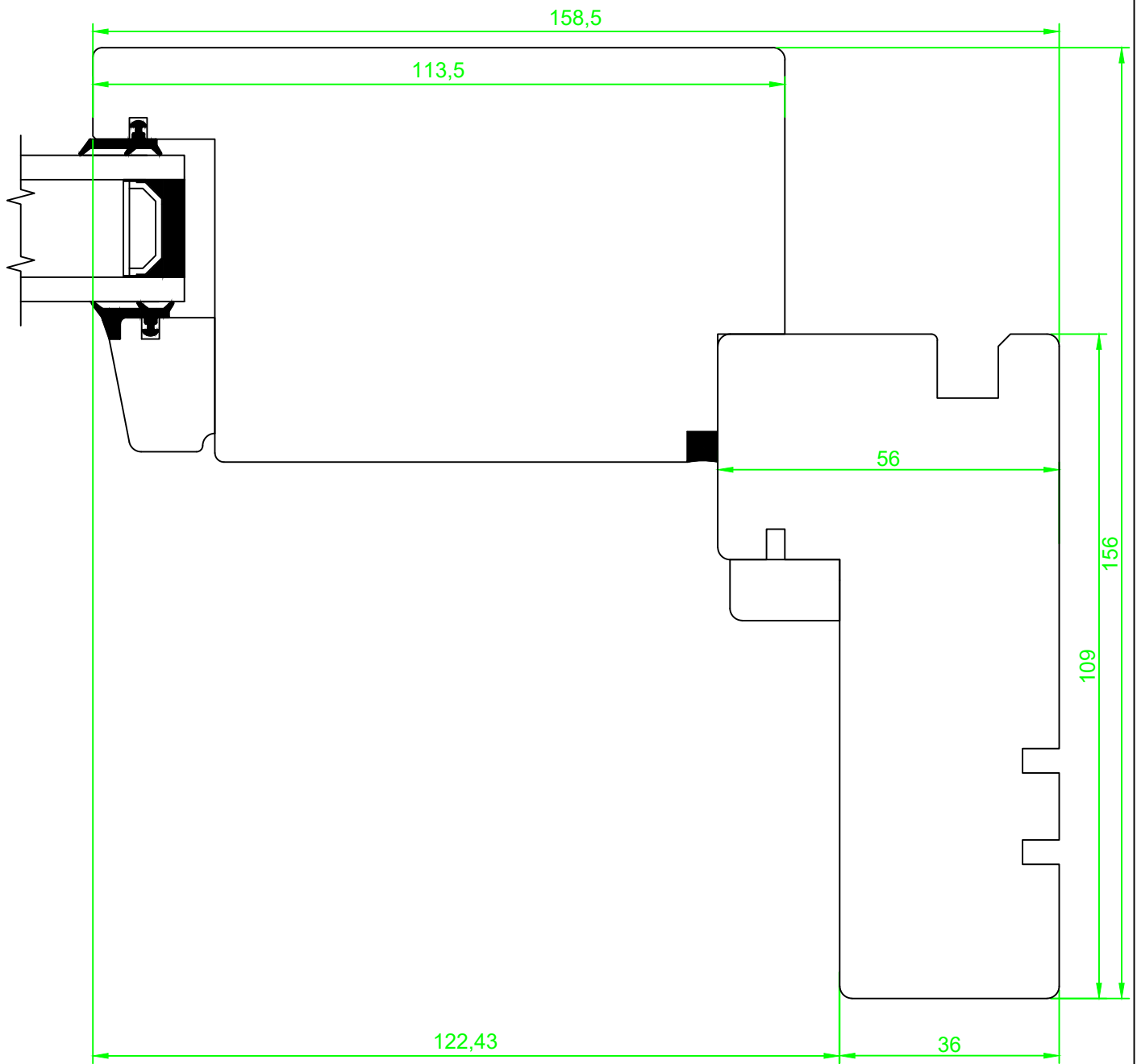

<i>Date.</i> 13.03.2017	<i>Constr./draw.</i> EAO	<i>Approved.</i>	<i>Scale.</i> 1:1	<i>Review nr.</i> Rev. 2	
Hev og senk skyvedør med GU beslag  Horizontalsnitt, detalj fastfeltside			<i>Material.</i>	 <small>Nordvestvinduet AS N-6713 ALMENNINGEN Tel +47 57 85 25 80 firmapost@nordvestvinduet.no www.nordvestvinduet.no</small>	
			<i>Replacement for:</i>		<i>Drawing nr.</i> SD_TR_FFS
			<i>Replaced of:</i>		
<i>Tolerance.:</i> NS-ISO 2768-1-middels.					

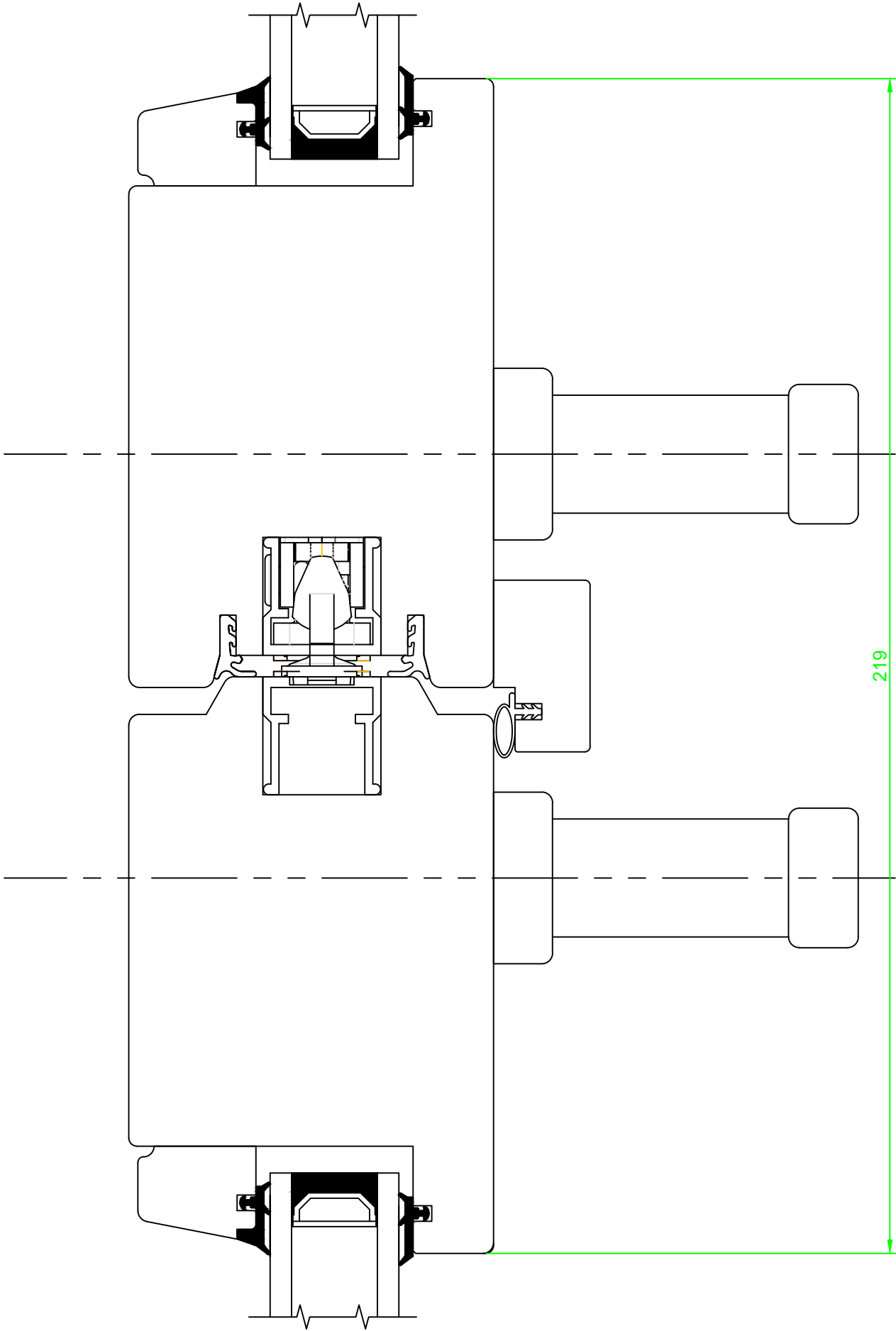

Dato:	13.01.2015	Konstr./Tegner:	EAO	Godkjent:		Rev. nr.	Rev. 2
Hov og senk skyvedør med GU beslag		Horizontalsnit, detalj midt SD4		Materialer:		Tegning nr.	
Referanse: AS-ISO 2788-F-modells				Materialer:		SD_TR_SD4	
				Erstatning for:			
				Erstatte av:			

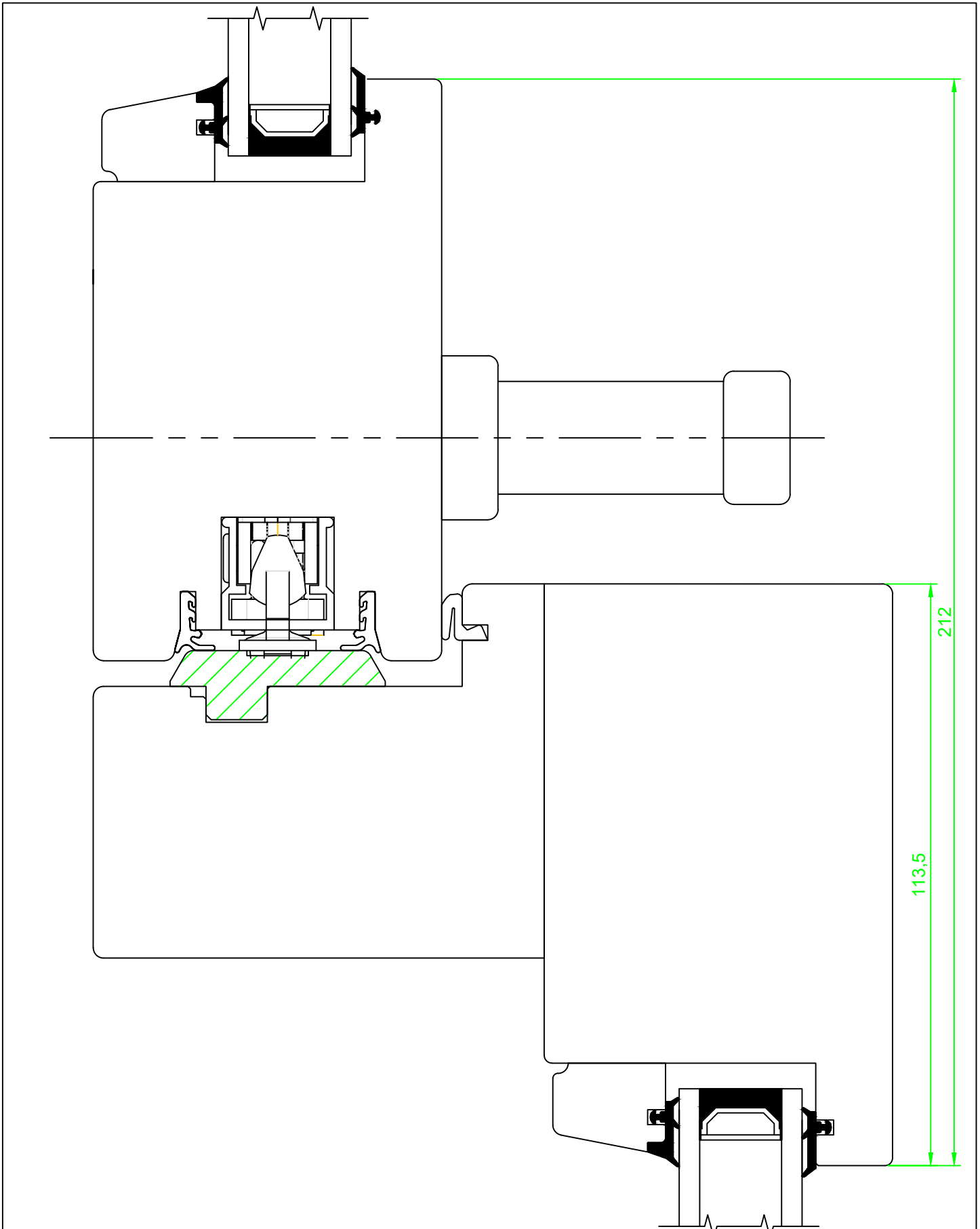

Date. 13.03.2017	Constr./draw. EAO	Approved.	Scale. 1:1	Review nr. Rev. 2
Skyvedørpost SDT3			Material.	 Nordvestvinduet AS N-6713 ALMENNINGEN Tel +47 57 85 25 80 firmapost@nordvestvinduet.no www.nordvestvinduet.no
Horizontalsnitt			Replacement for:	Drawing nr. SD3_TR_P
Tolerance.: NS-ISO 2768-1-middels.			Replaced of:	