

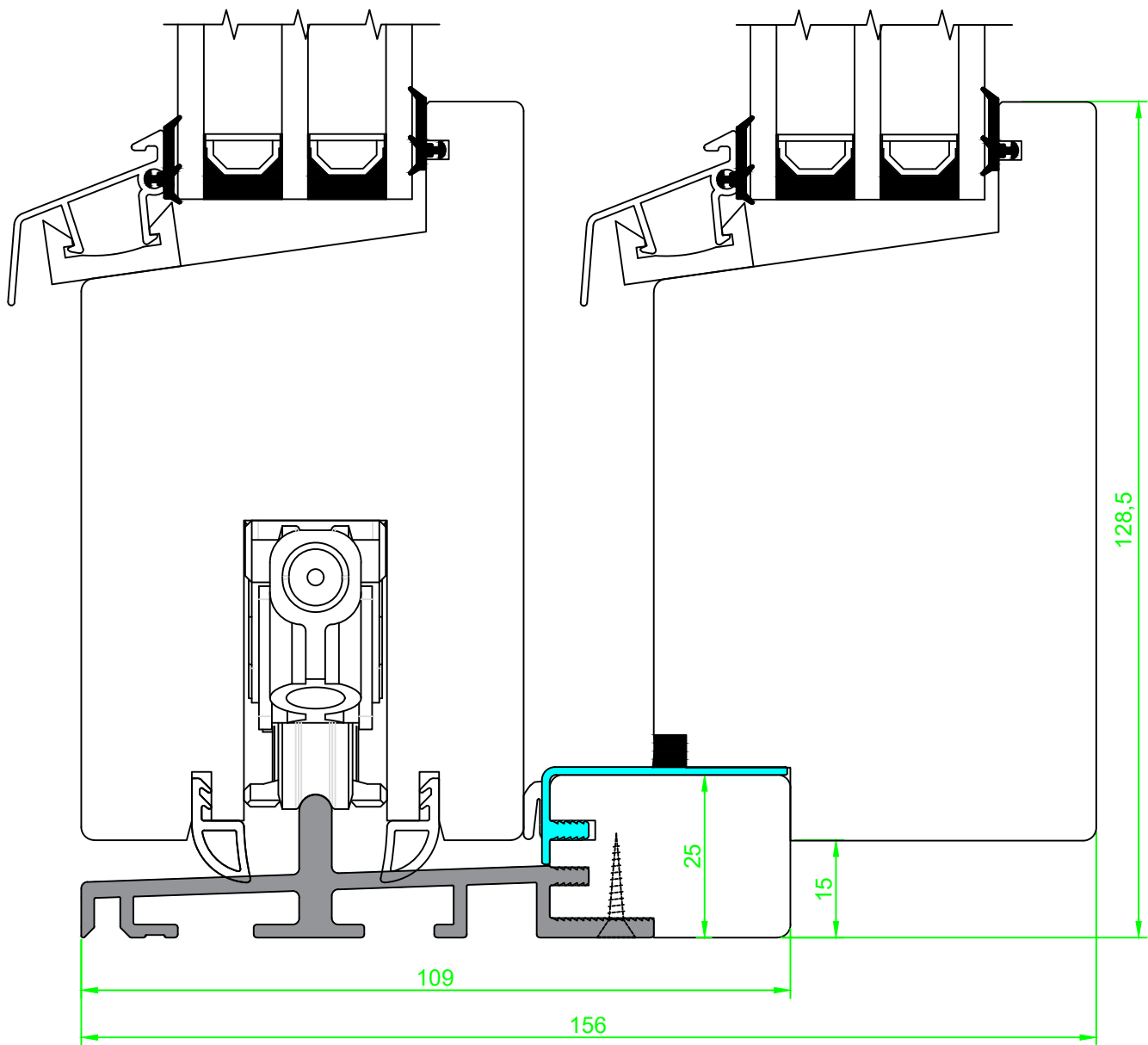



Date. 13.03.2017	Constr./draw. EAO	Approved.	Scale. 1:1	Review nr. Rev. 2
Hev og senk skyvedør med GU beslag Vertikalsnitt, detalj Bunn hardvedterskel			Material.	 Nordvestvinduet AS N-6713 ALMENNINGEN Tel +47 57 85 25 80 firmapost@nordvestvinduet.no www.nordvestvinduet.no
			Replacement for:	
			Tolerance.: NS-ISO 2768-1-middels.	Replaced of:



Date. 13.03.2017	Constr./draw. EAO	Approved.	Scale. 1:1	Review nr. Rev. 2
Hev og senk skyvedør med GU beslag			Material.	 Nordvestvinduet AS N-6713 ALMENNINGEN Tel +47 57 85 25 80 firmapost@nordvestvinduet.no www.nordvestvinduet.no
Vertikalsnitt, detalj Bunn HC-terskel			Replacement for:	
Tolerance.: NS-ISO 2768-1-middels.			Replaced of:	
			Drawing nr. SD_TR_B_G36_HC	

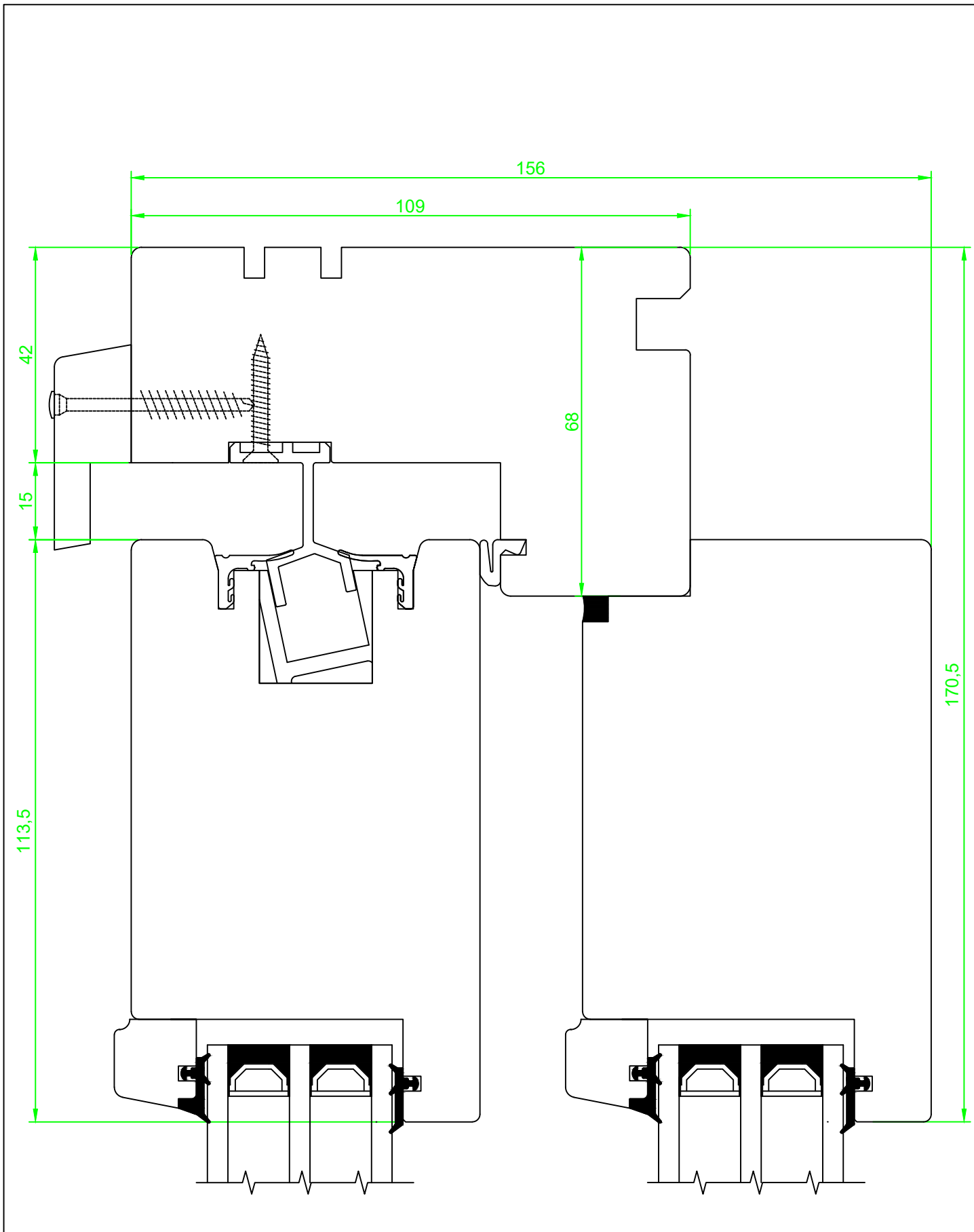

Date. 13.03.2017	Constr./draw. EAO	Approved.	Scale. 1:1	Review nr. Rev. 2
Hev og senk skyvedør med GU beslag Vertikalsnitt, detalj topp			Material.	 Nordvestvinduet AS N-6713 ALMENNINGEN Tel +47 57 85 25 80 firmapost@nordvestvinduet.no www.nordvestvinduet.no
			Replacement for:	
Tolerance.: NS-ISO 2768-1-middels.			Replaced of:	

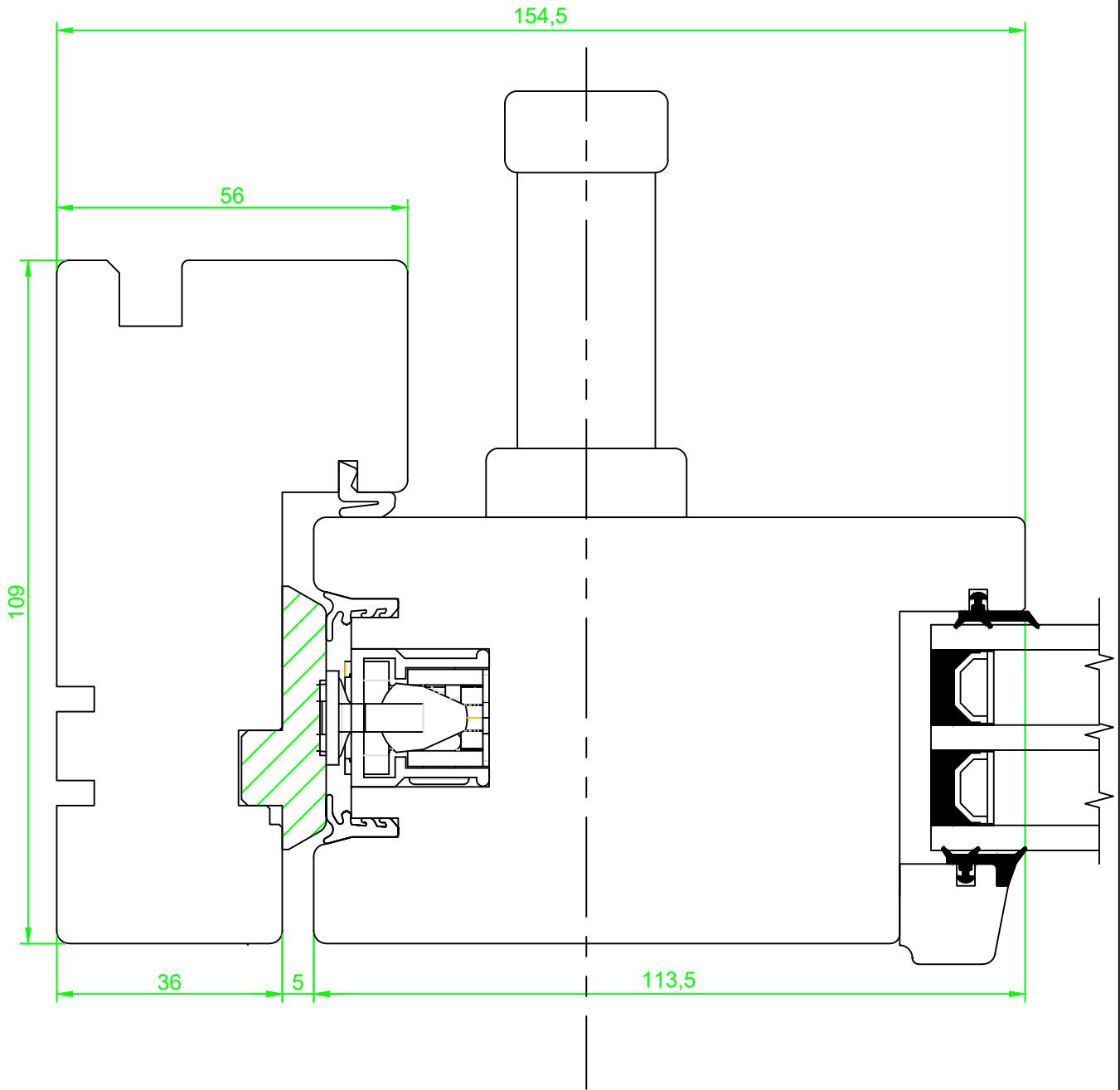

Date. 13.01.2015	Constr./draw. EAO	Approved.	Scale. 1:1	Review nr. Rev. 2
Hev og senk skyvedør med GU beslag Horisontalsnitt, detalj låsside			Material.	 Nordvestvinduet AS N-6713 ALMENNINGEN Tel +47 57 85 25 80 firmapost@nordvestvinduet.no www.nordvestvinduet.no
			Replacement for:	
Tolerance.: NS-ISO 2768-1-middels.			Replaced of:	

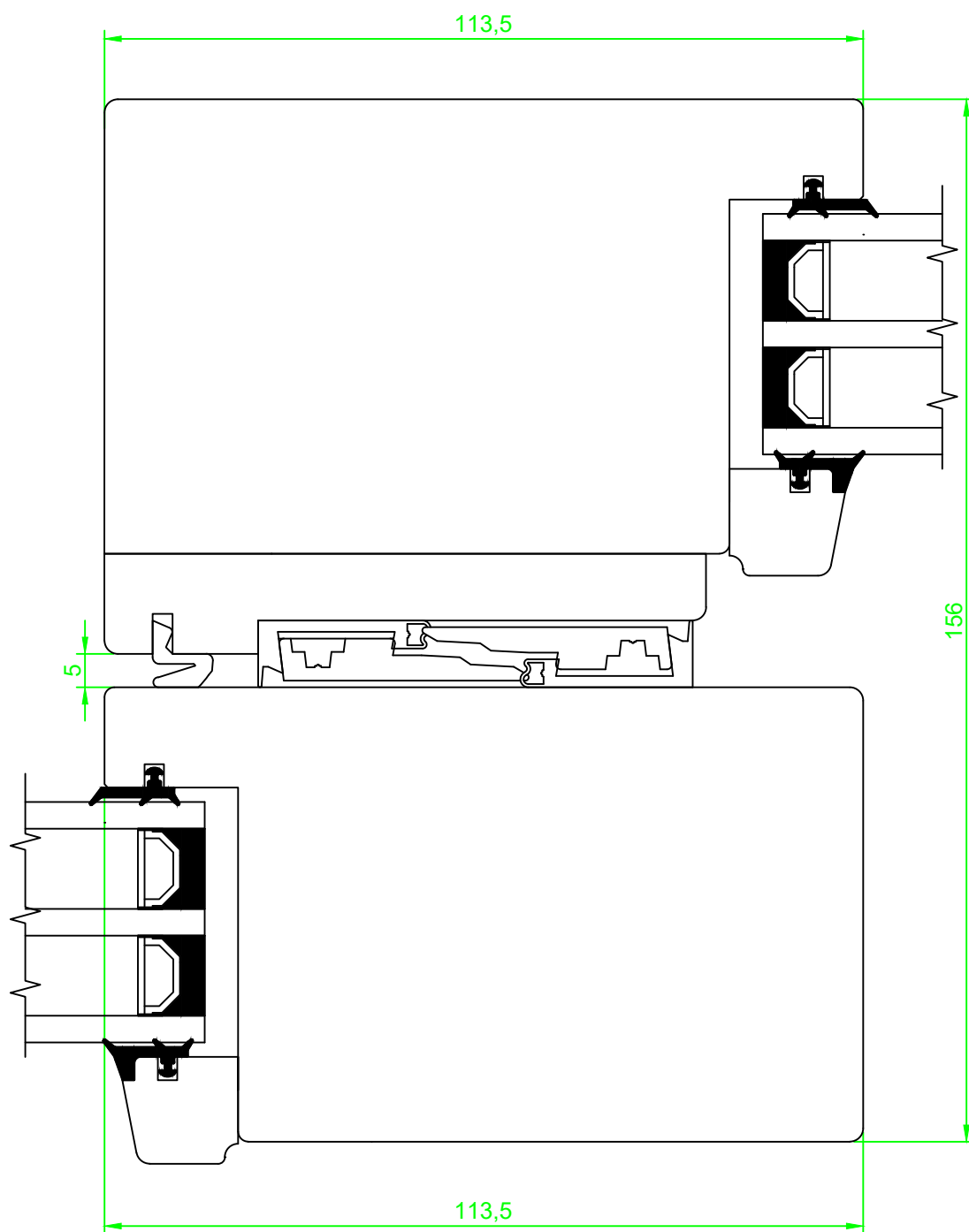

<i>Date.</i> 13.03.2017	<i>Constr./draw.</i> RS/EAO	<i>Approved.</i>	<i>Scale.</i> 1:1	<i>Review nr.</i> Rev. 2
Hev og senk skyvedør med GU beslag Horizontalsnitt, detalj midt			<i>Material.</i>	 Nordvestvinduet AS N-6713 ALMENNINGEN Tel +47 57 85 25 80 firmapost@nordvestvinduet.no www.nordvestvinduet.no
			<i>Replacement for:</i>	
<i>Tolerance.:</i> NS-ISO 2768-1-middels.			<i>Replaced of:</i>	

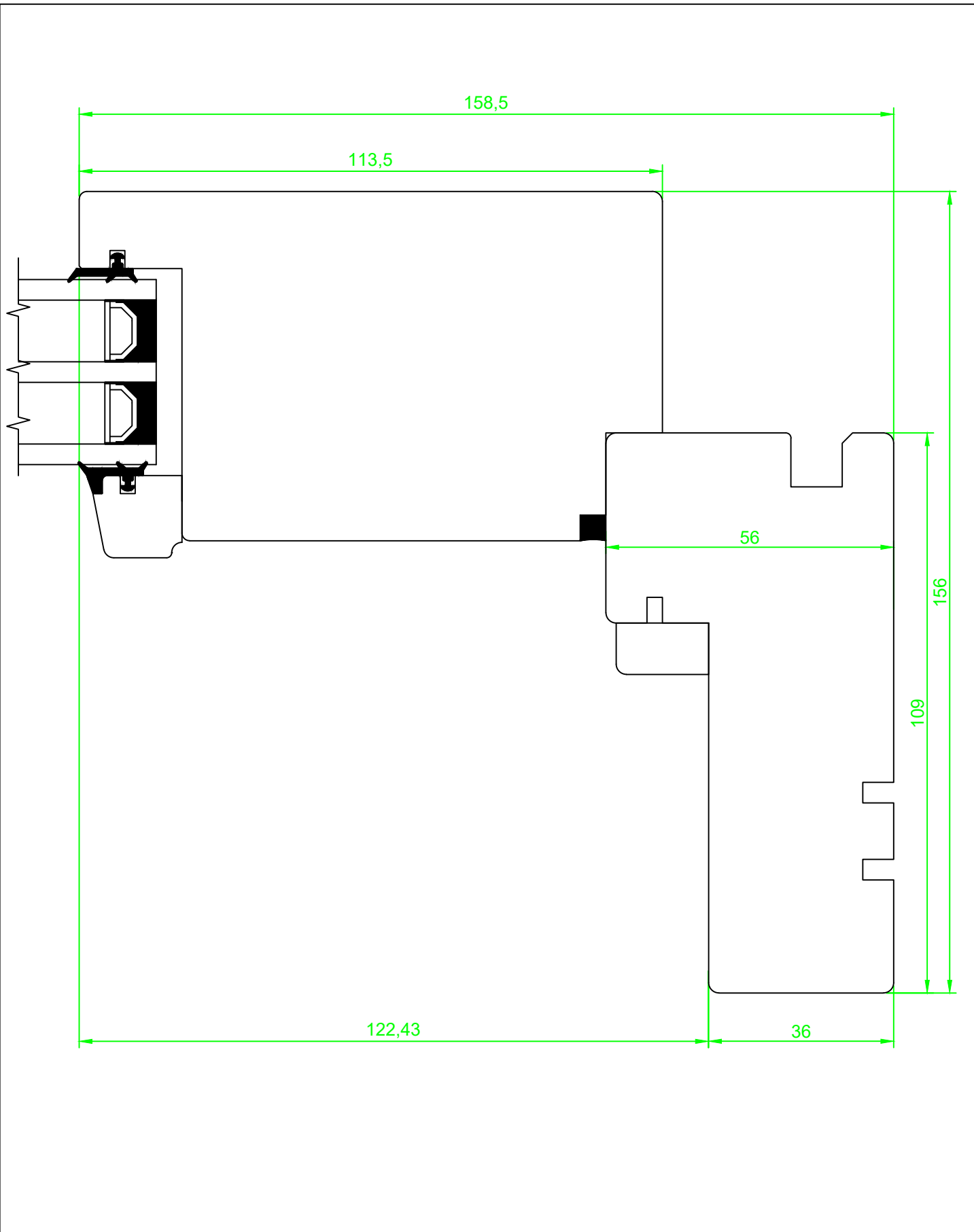

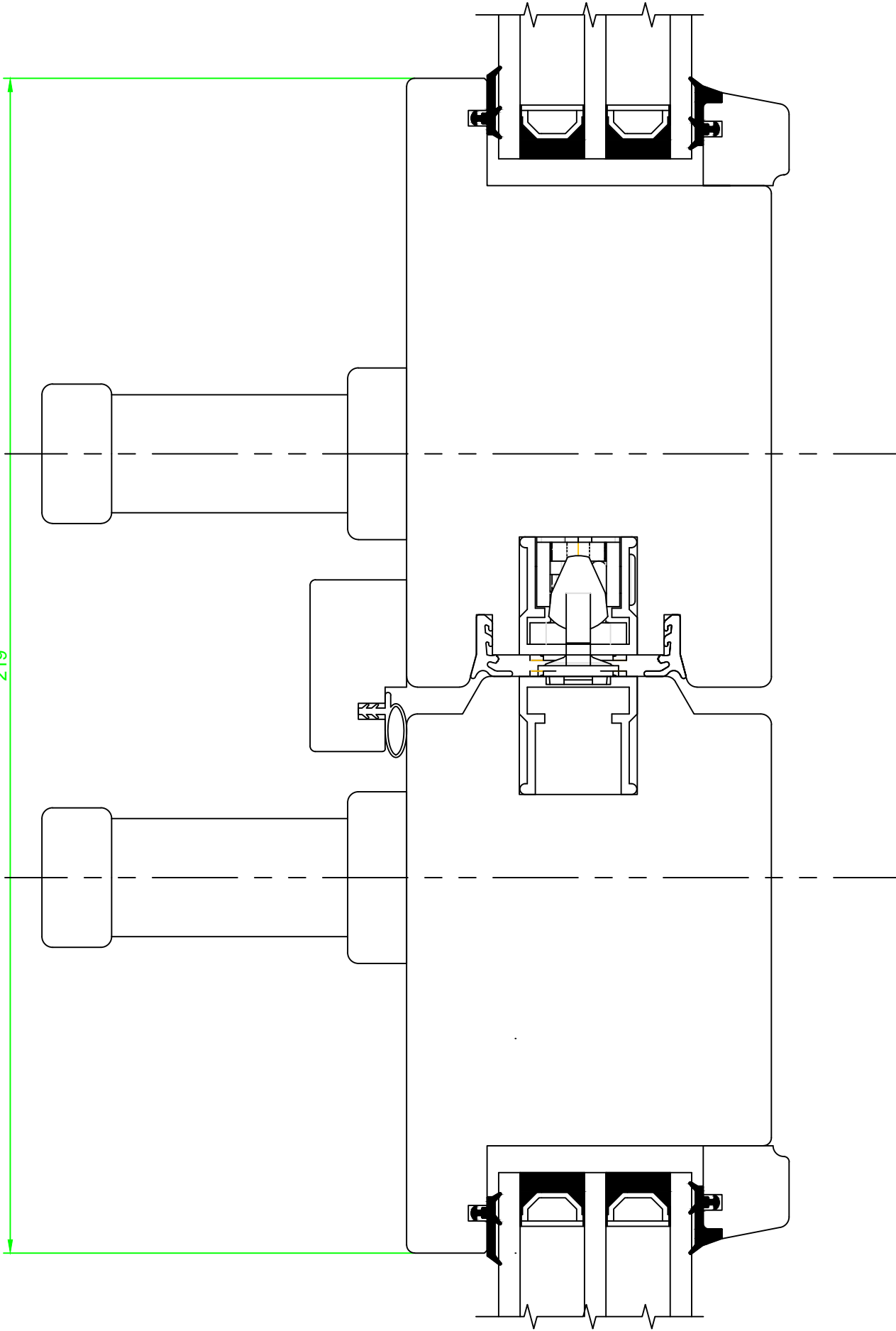

<i>Date.</i> 13.03.2017	<i>Constr./draw.</i> EAO	<i>Approved.</i>	<i>Scale.</i> 1:1	<i>Review nr.</i> Rev. 2
Hev og senk skyvedør med GU beslag Horisontalsnitt, detalj fastfeltside			<i>Material.</i>	 Nordvestvinduet AS N-6713 ALMENNINGEN Tel +47 57 85 25 80 firmapost@nordvestvinduet.no www.nordvestvinduet.no
			<i>Replacement for:</i>	
<i>Tolerance.:</i> NS-ISO 2768-1-middels.			<i>Replaced of:</i>	

219

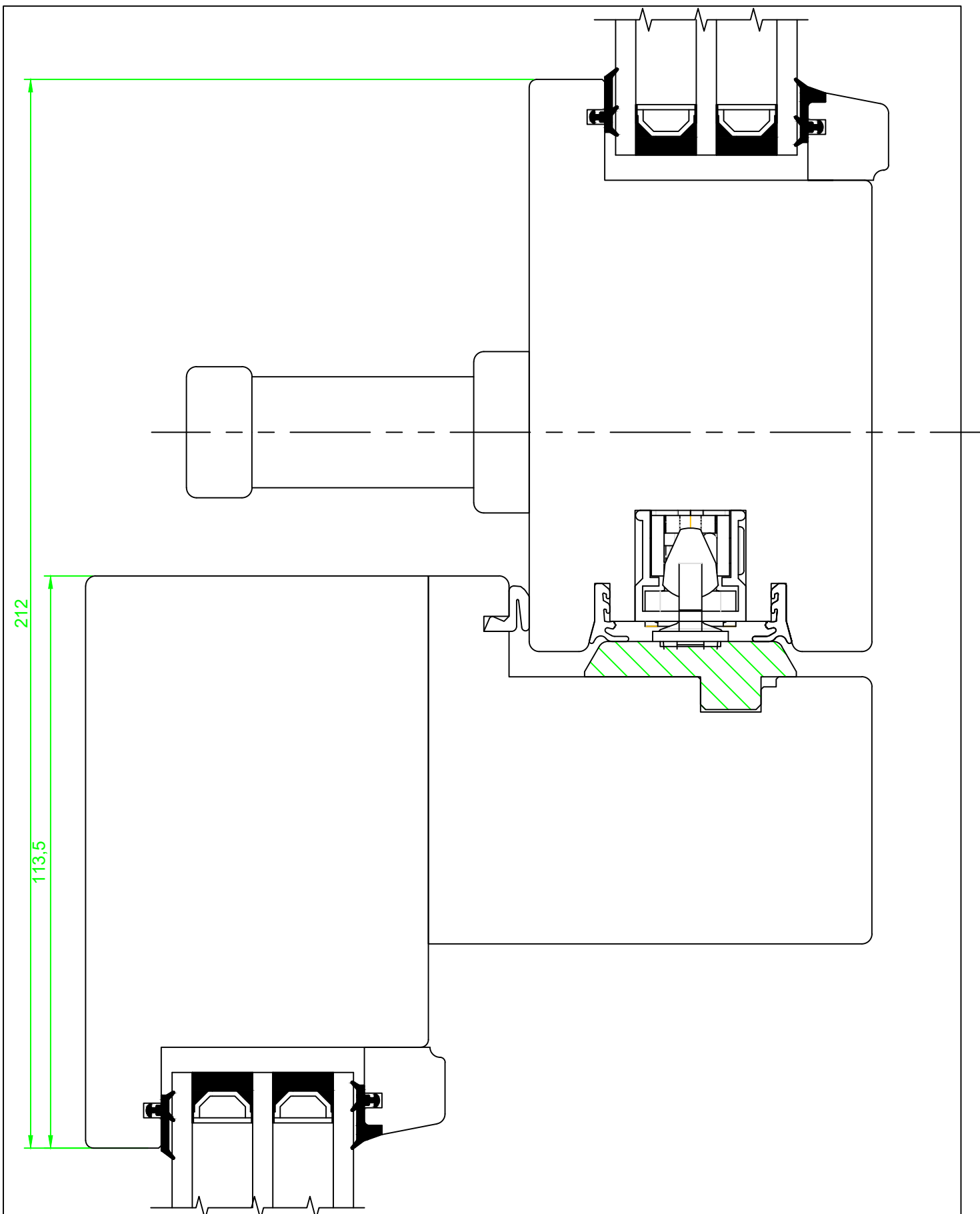

Date	13.01.2015	Konstr./Tegnet	EAO	Godkjent		Rev. nr.	Rev. 2
Hev og senk skyvedør med GU beslag				Målestokk:		MATEMATISKE INSTRUMENTER FRA BRUNNEN 1885	
Horisontalsnitt, detalj midt SD4				Materiale:		Tegning nr.	
				Ersättning för:		SD_TR_G36_SD4	
				Ersätter av:		Toleranse: NS-ISO 2768-T-middels	



Date. 13.03.2017	Constr./draw. EAO	Approved.	Scale. 1:1	Review nr. Rev. 2
Skyvedørpost SDT3			Material.	 <small>Nordvestvinduet AS N-6713 ALMENNINGEN Tel +47 57 85 25 80 firmapost@nordvestvinduet.no www.nordvestvinduet.no</small>
Horisontalsnitt			Replacement for:	Drawing nr. SD3_TR_G36_SD3
Tolerance.: NS-ISO 2768-1-middels.			Replaced of:	