

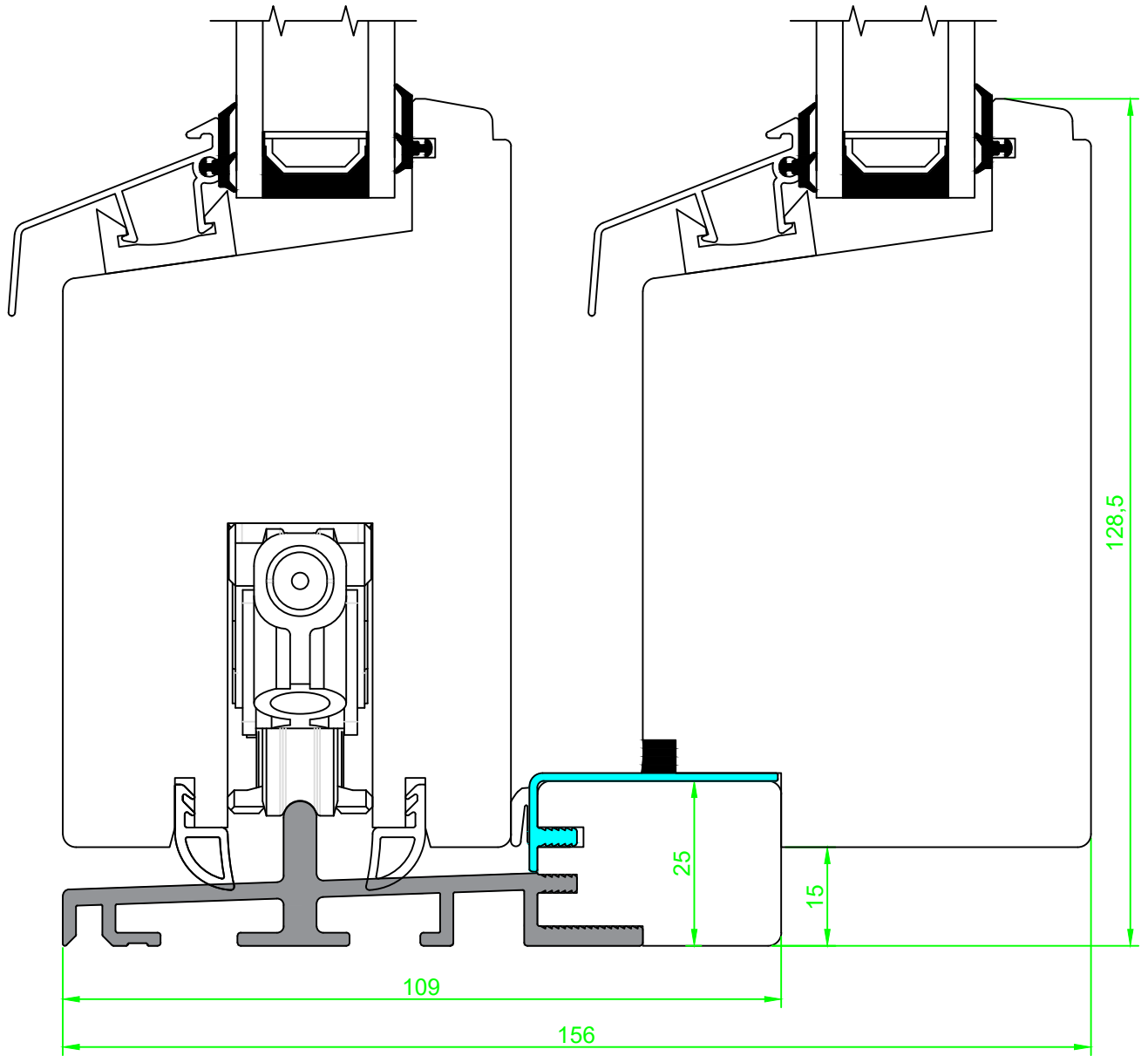



Date. 13.03.2017	Constr./draw. EAO	Approved.	Scale. 1:1	Review nr. Rev. 2
Hev og senk skyvedør med GU beslag Vertikalsnitt, detalj Bunn hardvedterskel			Material.	 Nordvestvinduet AS N-6713 ALMENNINGEN Tel +47 57 85 25 80 firmapost@nordvestvinduet.no www.nordvestvinduet.no
			Replacement for:	
Tolerance.: NS-ISO 2768-1-middels.			Replaced of:	SD_STD_B



<i>Date.</i> 13.03.2017	<i>Constr./draw.</i> EAO	<i>Approved.</i>	<i>Scale.</i> 1:1	<i>Review nr.</i> Rev. 2
Hev og senk skyvedør med GU beslag Vertikalsnitt, detalj Bunn HC-terskel			<i>Material.</i>	 <small>Nordvestvinduet AS N-6713 ALMENNINGEN Tel +47 57 85 25 80 firmapost@nordvestvinduet.no www.nordvestvinduet.no</small>
			<i>Replacement for:</i>	
<i>Tolerance.:</i> NS-ISO 2768-1-middels.			<i>Replaced of:</i>	

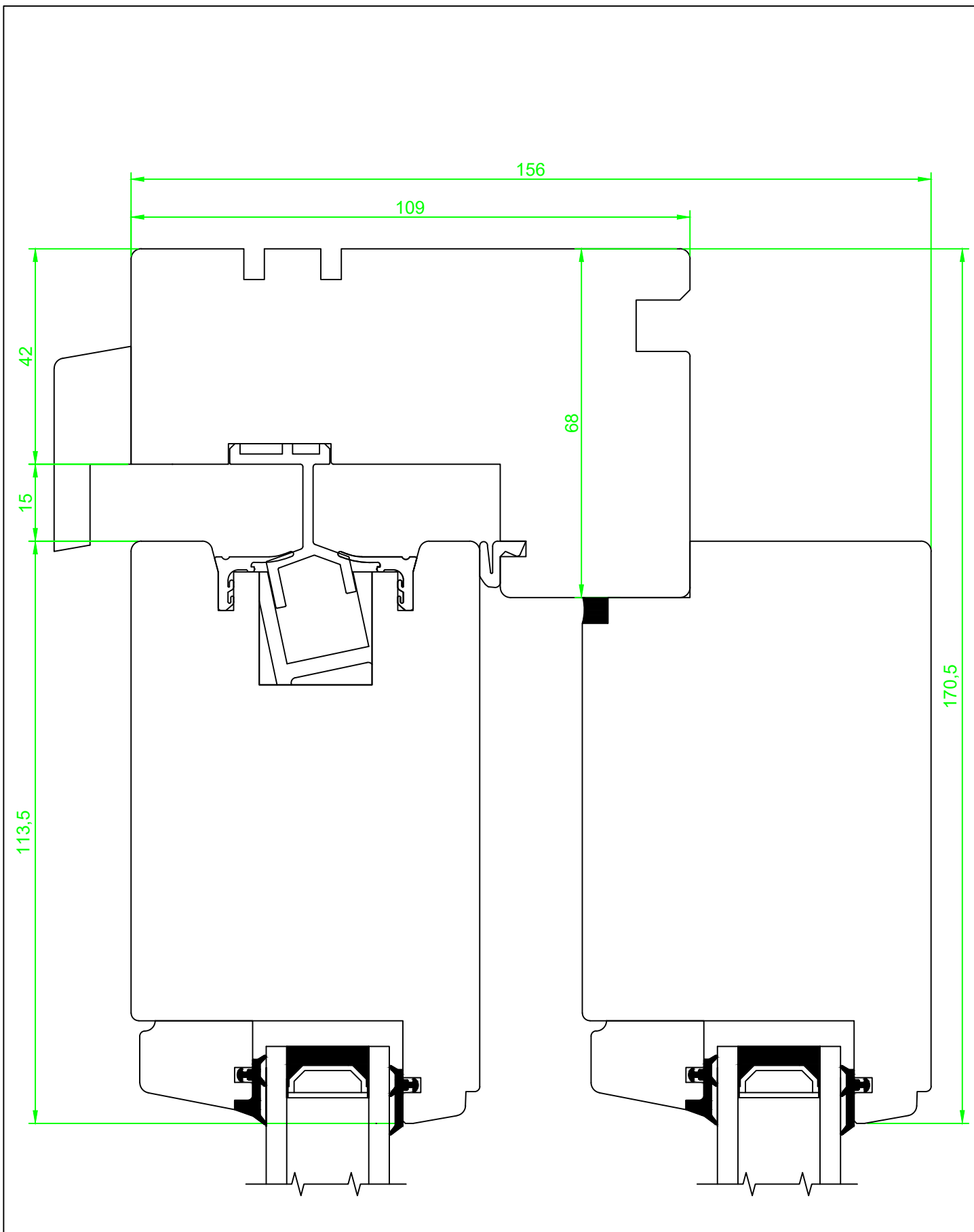

Date. 13.03.2017	Constr./draw. EAO	Approved.	Scale. 1:1	Review nr. Rev. 2	
Hev og senk skyvedør med GU beslag Vertikalsnitt, detalj topp			Material.	 Nordvestvinduet AS N-6713 ALMENNINGEN Tel +47 57 85 25 80 firmapost@nordvestvinduet.no www.nordvestvinduet.no	
			Replacement for:		Drawing nr.
			Replaced of:		SD_STD_O
Tolerance.: NS-ISO 2768-1-middels.					

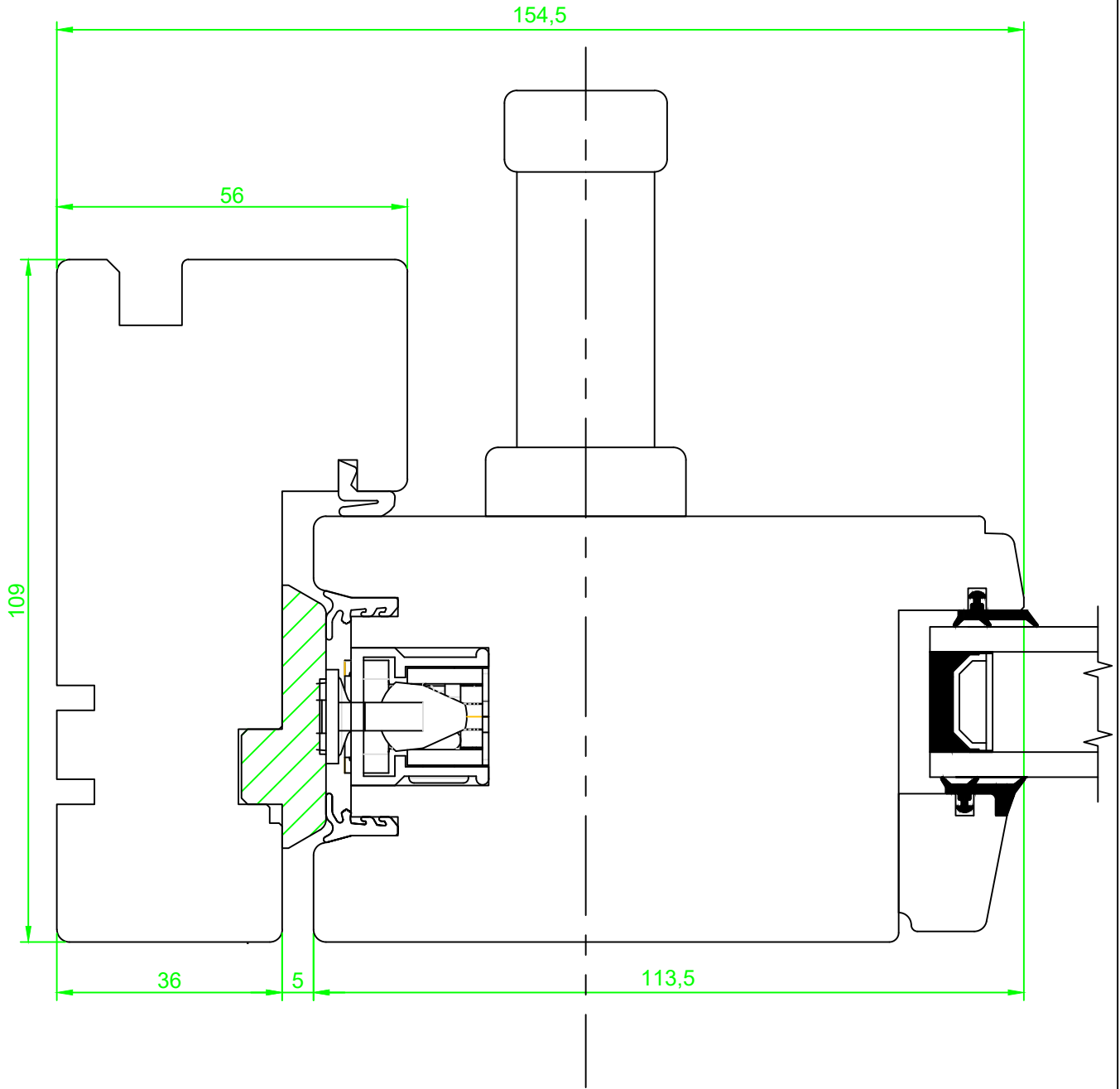

Date. 14.02.2017	Constr./draw. EAO	Approved.	Scale. 1:1	Review nr. Rev. 2
Hev og senk skyvedør med GU beslag			Material.	 Nordvestvinduet AS N-6713 ALMENNINGEN Tel +47 57 85 25 80 firmapost@nordvestvinduet.no www.nordvestvinduet.no
Horizontalsnitt, detalj låsside			Replacement for:	
Tolerance.: NS-ISO 2768-1-middels.			Replaced of:	
			Drawing nr. SD_STD_SFS	

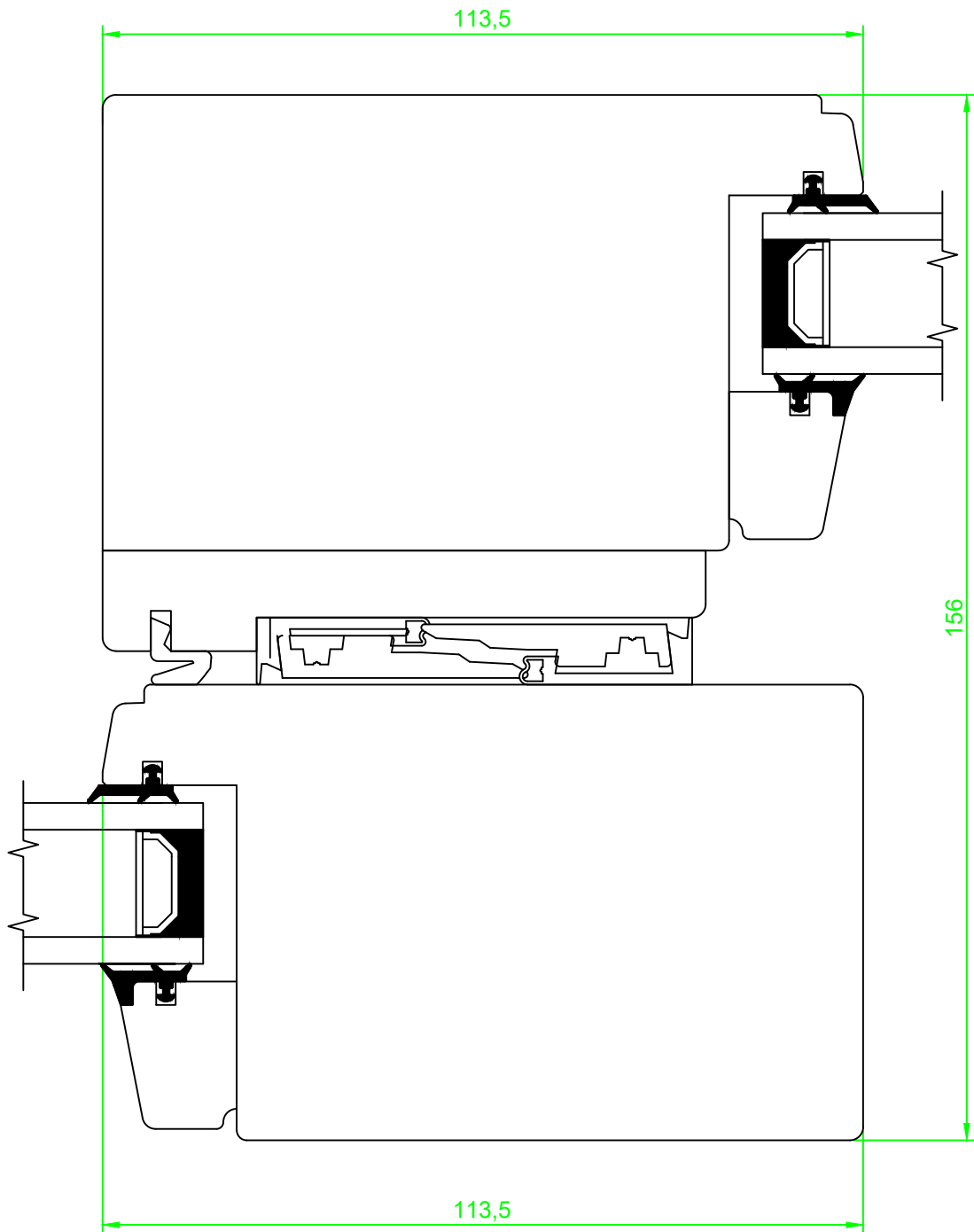

Date. 13.03.2017	Constr./draw. RS/EAO	Approved.	Scale. 1:1	Review nr. Rev. 2
Hev og senk skyvedør med GU beslag			Material.	 Nordvestvinduet AS N-6713 ALMENNINGEN Tel +47 57 85 25 80 firmapost@nordvestvinduet.no www.nordvestvinduet.no
Horisontalsnitt, detalj midt			Replacement for:	
Tolerance.: NS-ISO 2768-1-middels.			Replaced of:	
				Drawing nr. SD_STD_SFM

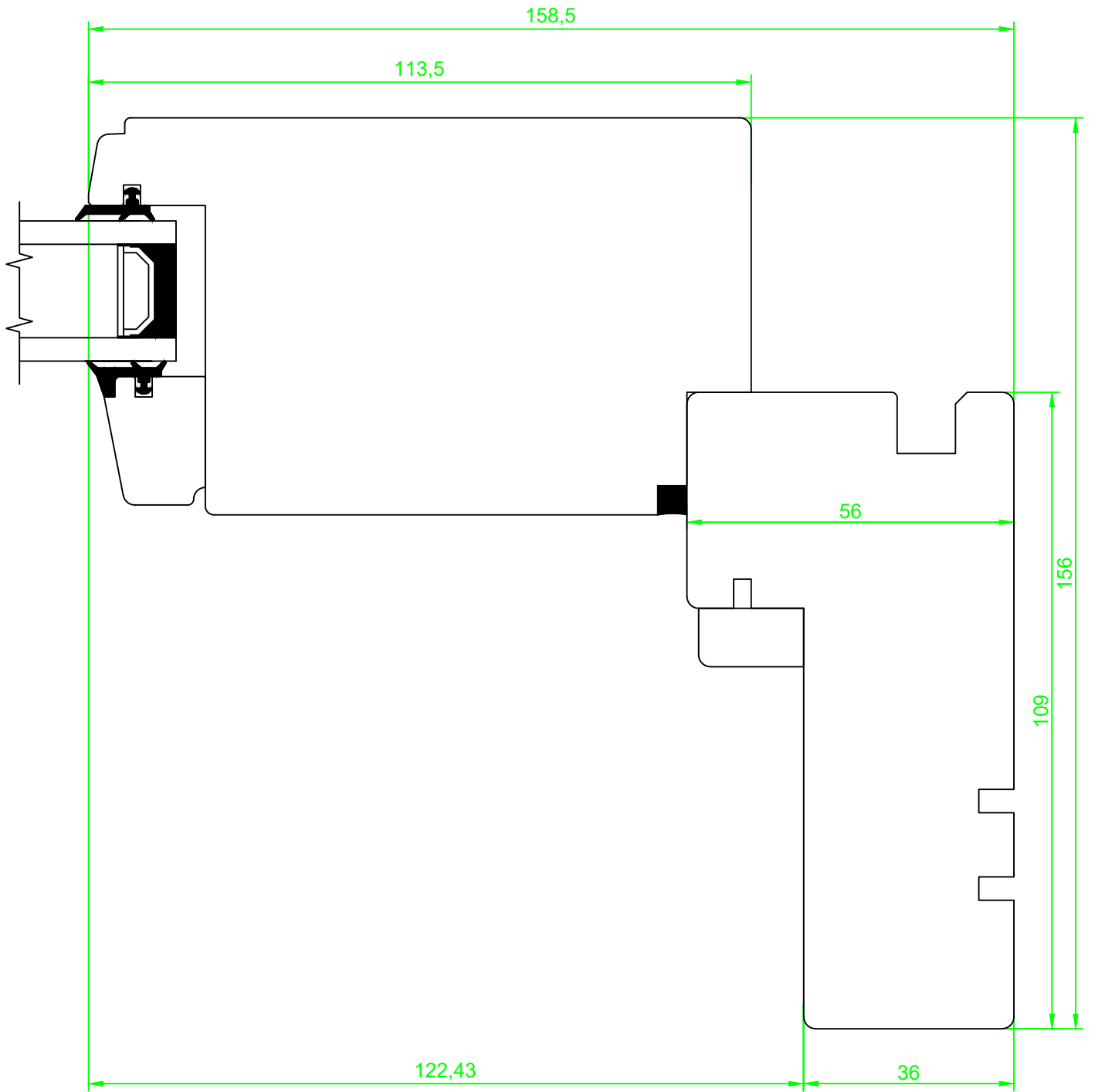

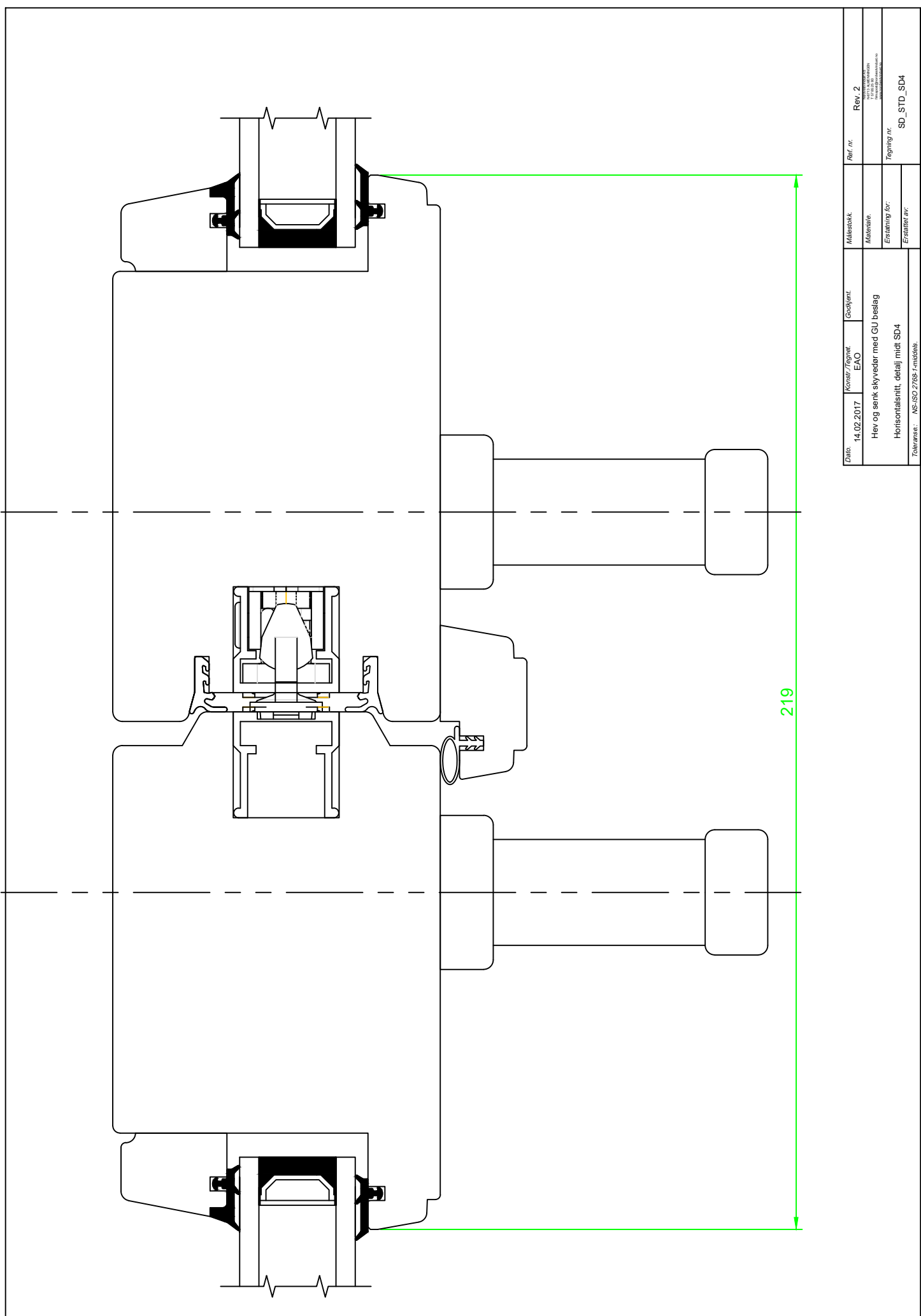

Date. 13.03.2017	Constr./draw. EAO	Approved.	Scale. 1:1	Review nr. Rev. 2
Hev og senk skyvedør med GU beslag Horisontalsnitt, detalj fastfeltside			Material.	 Nordvestvinduet AS N-6713 ALMENNINGEN Tel +47 57 85 25 80 firmapost@nordvestvinduet.no www.nordvestvinduet.no
			Replacement for:	
Tolerance.: NS-ISO 2768-1-middels.			Replaced of:	

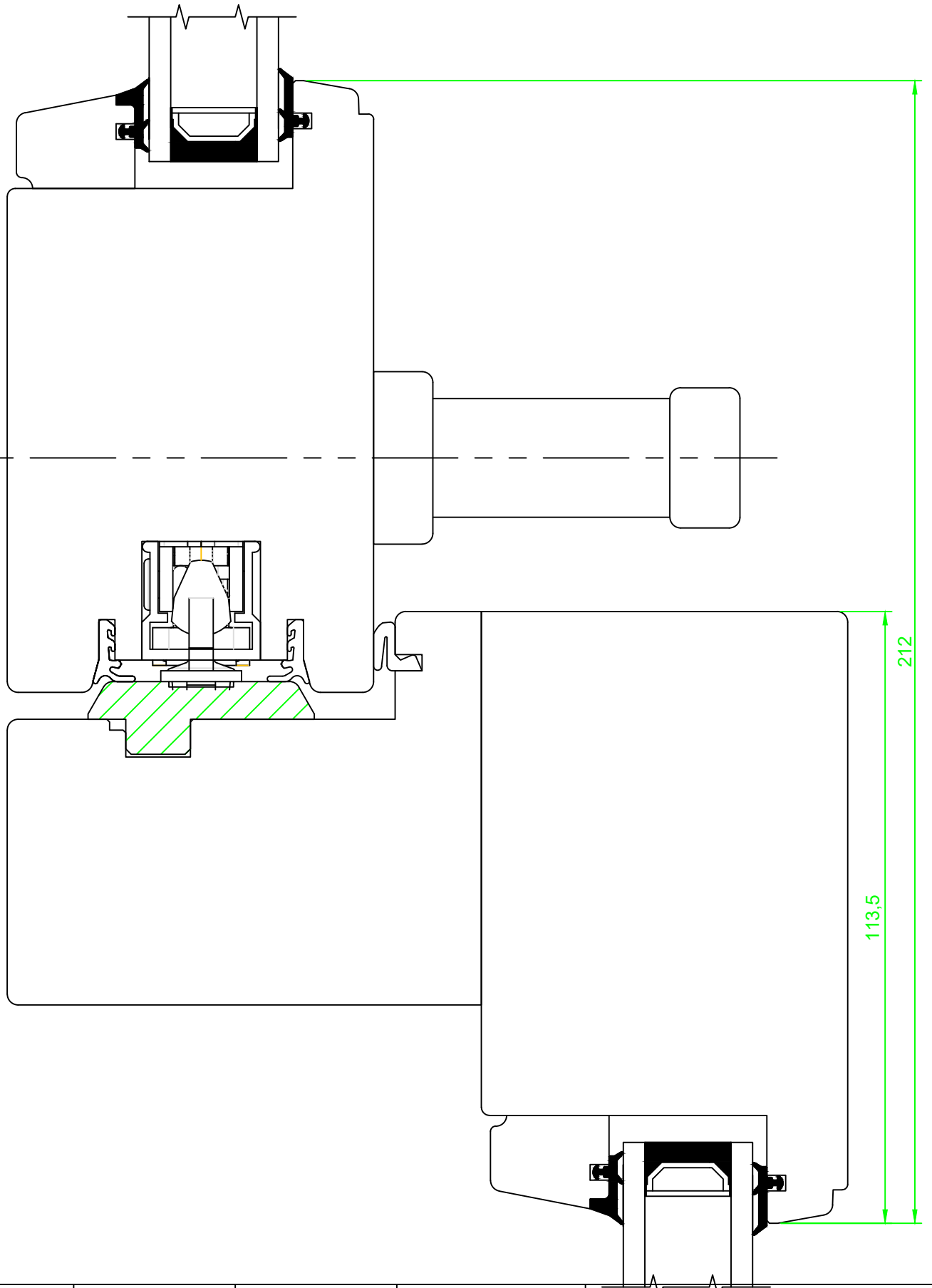

Dato:	14.02.2017	Konstr./Tegner:	EAO	Godkjent:		Målestokk:		Rev. nr.:	Rev. 2
						Materiale:			
						Erstatning for:		Tegning nr.:	SD_STD_SD4
						Toleranse:	NS/ISO 27683-1-2003		

219



<i>Date.</i> 13.03.2017	<i>Constr./draw.</i> EAO	<i>Approved.</i>	<i>Scale.</i> 1:1	<i>Review nr.</i> Rev. 2	
Skyvedørpost SDT3			<i>Material.</i>	 Nordvestvinduet AS N-6713 ALMENNINGEN Tel +47 57 85 25 80 firmapost@nordvestvinduet.no www.nordvestvinduet.no	
Horisontalsnitt			<i>Replacement for:</i>		<i>Drawing nr.</i> SD3_STD_P
			<i>Replaced of:</i>		
<i>Tolerance.:</i> NS-ISO 2768-1-middels.					