

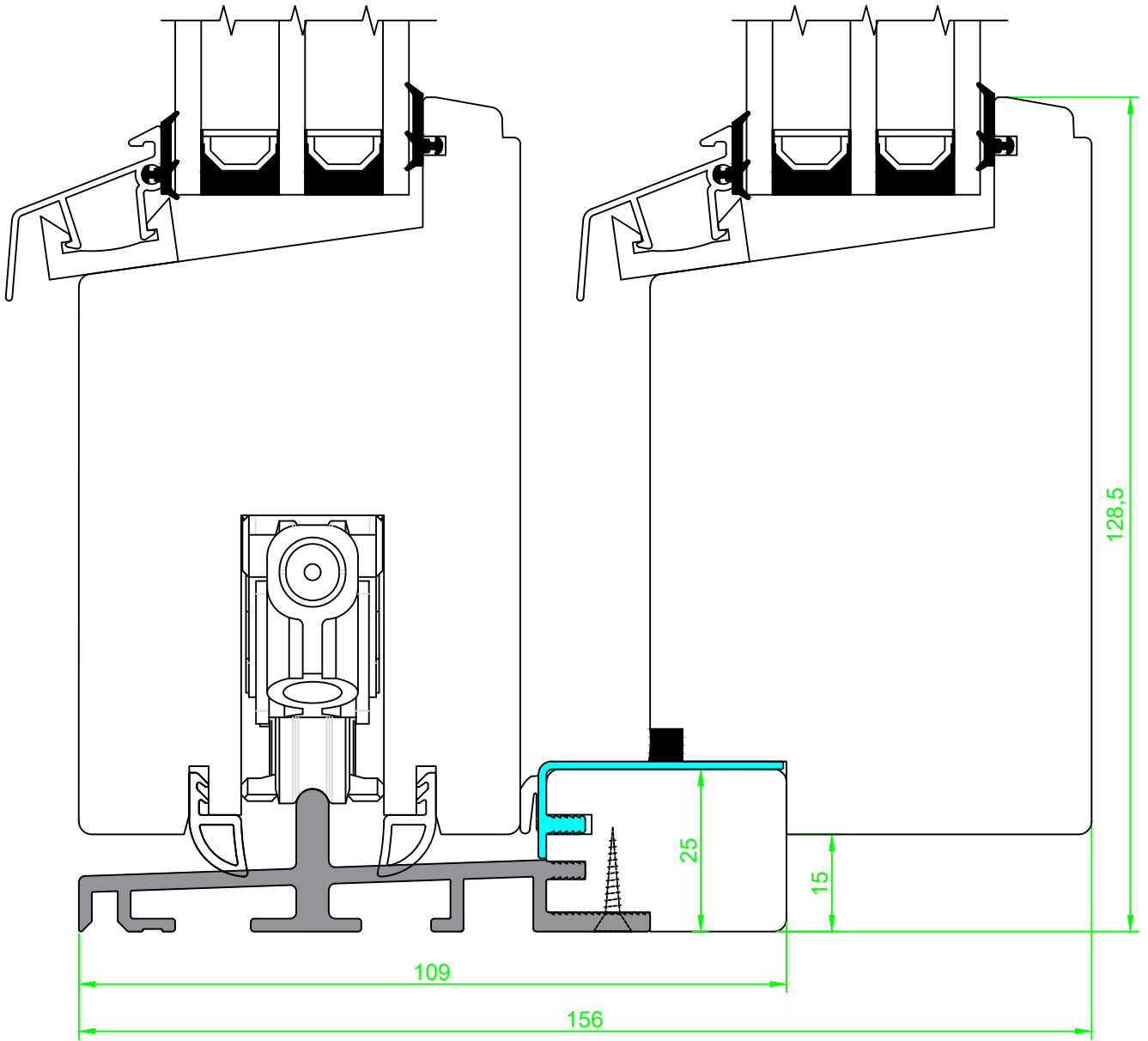



Date. 13.03.2017	Constr./draw. EAO	Approved.	Scale. 1:1	Review nr. Rev. 2
Hev og senk skyvedør med GU beslag			Material.	 Nordvestvinduet AS N-6713 ALMENNINGEN Tel +47 57 85 25 80 firmapost@nordvestvinduet.no www.nordvestvinduet.no
Vertikalsnitt, detalj Bunn hardvedterskel			Replacement for:	
Tolerance.: NS-ISO 2768-1-middels.			Replaced of:	
				Drawing nr. SD_STD_G36_B



Date. 13.03.2017	Constr./draw. EAO	Approved.	Scale. 1:1	Review nr. Rev. 2
Hev og senk skyvedør med GU beslag Vertikalsnitt, detalj Bunn HC-terskel			Material.	 Nordvestvinduet AS N-6713 ALMENNINGEN Tel +47 57 85 25 80 firmapost@nordvestvinduet.no www.nordvestvinduet.no
			Replacement for:	
Tolerance.: NS-ISO 2768-1-middels.			Replaced of:	SD_STD_B_G36_HC

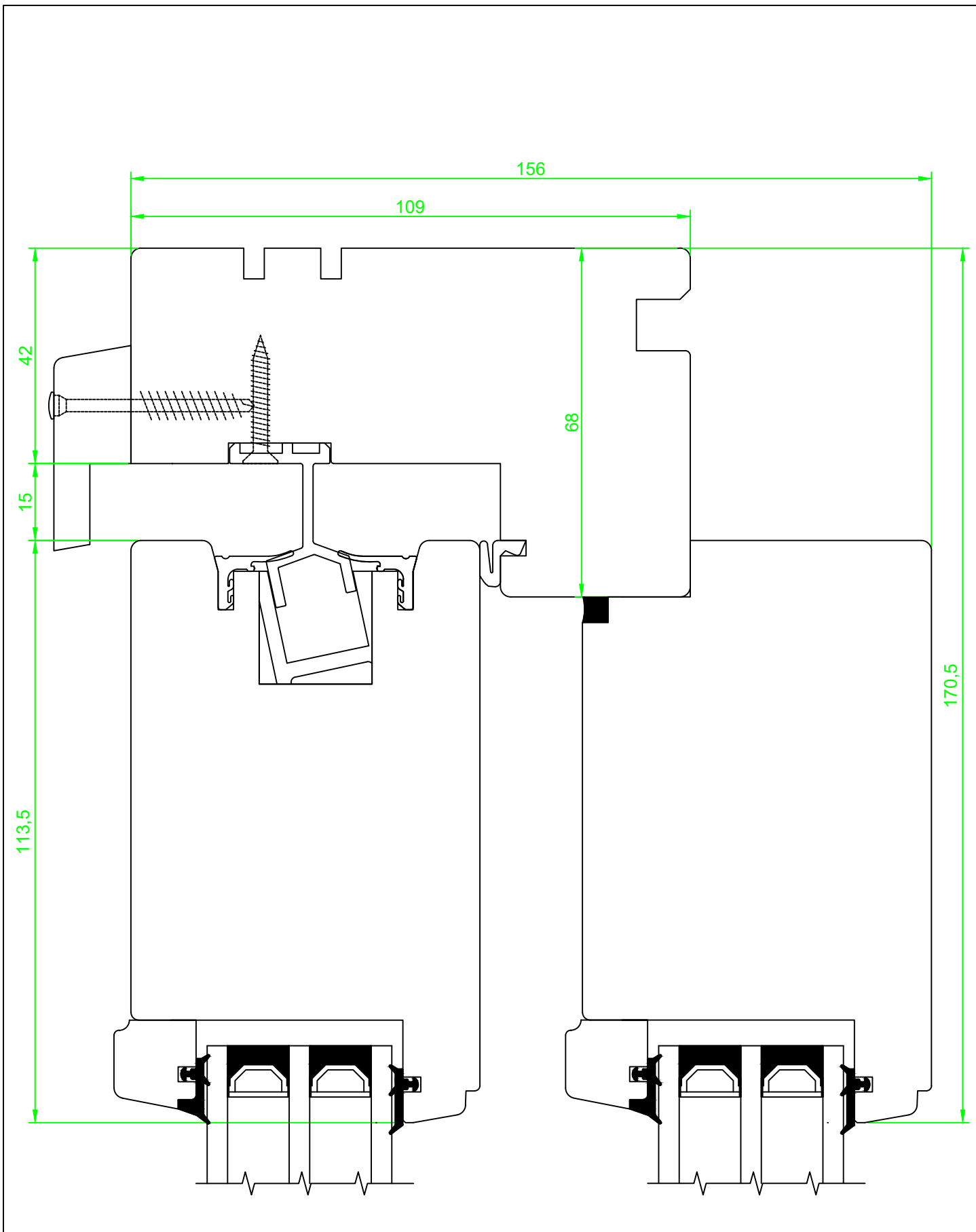

Date. 13.03.2017	Constr./draw. EAO	Approved.	Scale. 1:1	Review nr. Rev. 2
Hev og senk skyvedør med GU beslag Vertikalsnitt, detalj topp			Material.	 Nordvestvinduet AS N-6713 ALMENNINGEN Tel +47 57 85 25 80 firmapost@nordvestvinduet.no www.nordvestvinduet.no
			Replacement for:	
Tolerance.: NS-ISO 2768-1-middels.			Replaced of:	

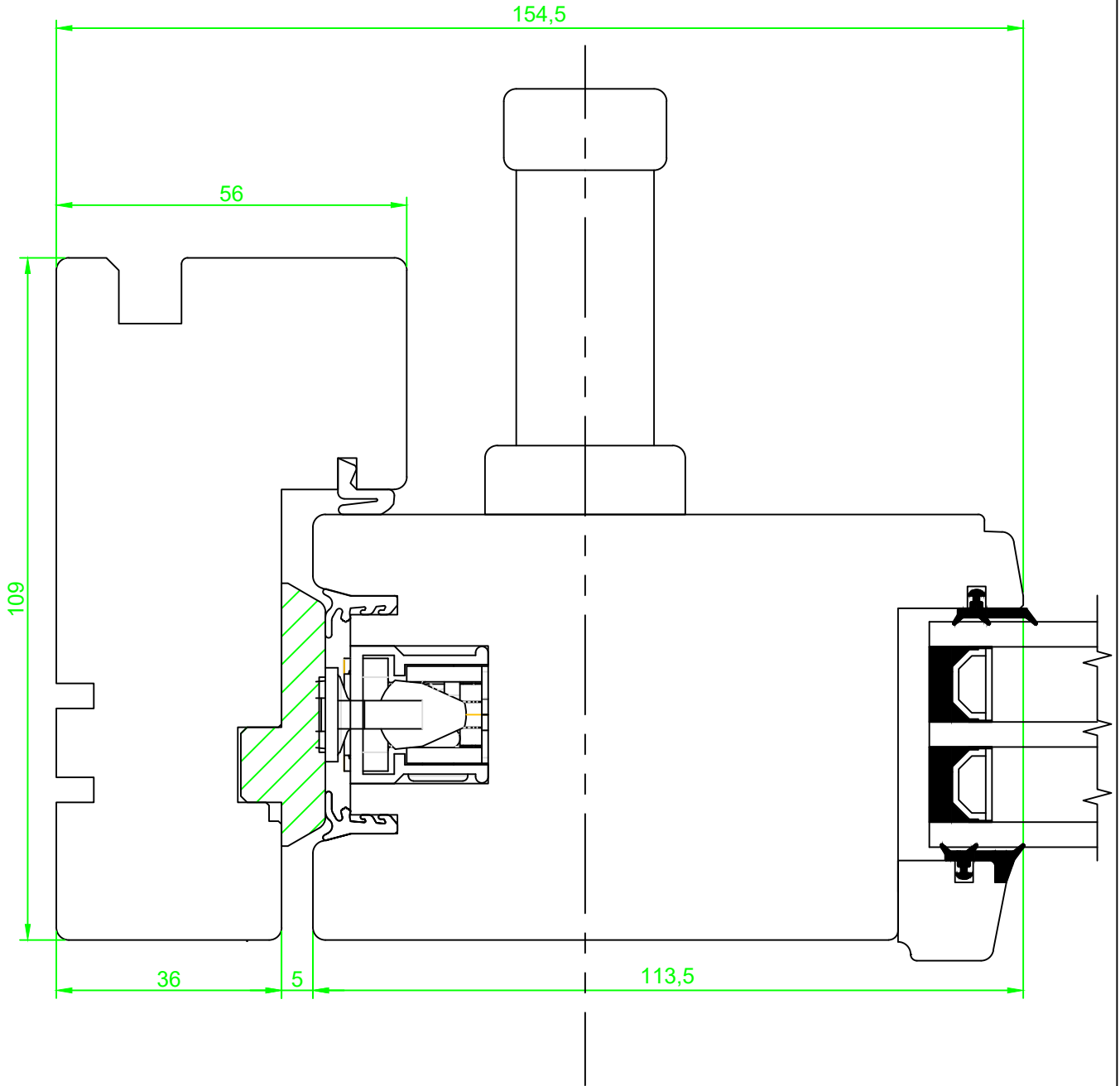

<i>Date.</i> 14.02.2017	<i>Constr./draw.</i> EAO	<i>Approved.</i>	<i>Scale.</i> 1:1	<i>Review nr.</i> Rev. 2
Hev og senk skyvedør med GU beslag Horizontalsnitt, detalj låsside			<i>Material.</i>	 Nordvestvinduet AS N-8713 ALMIENNINGEN Tel +47 57 85 25 80 firmapost@nordvestvinduet.no www.nordvestvinduet.no
			<i>Replacement for:</i>	
<i>Tolerance.: NS-ISO 2768-1-middels.</i>			<i>Replaced of:</i>	

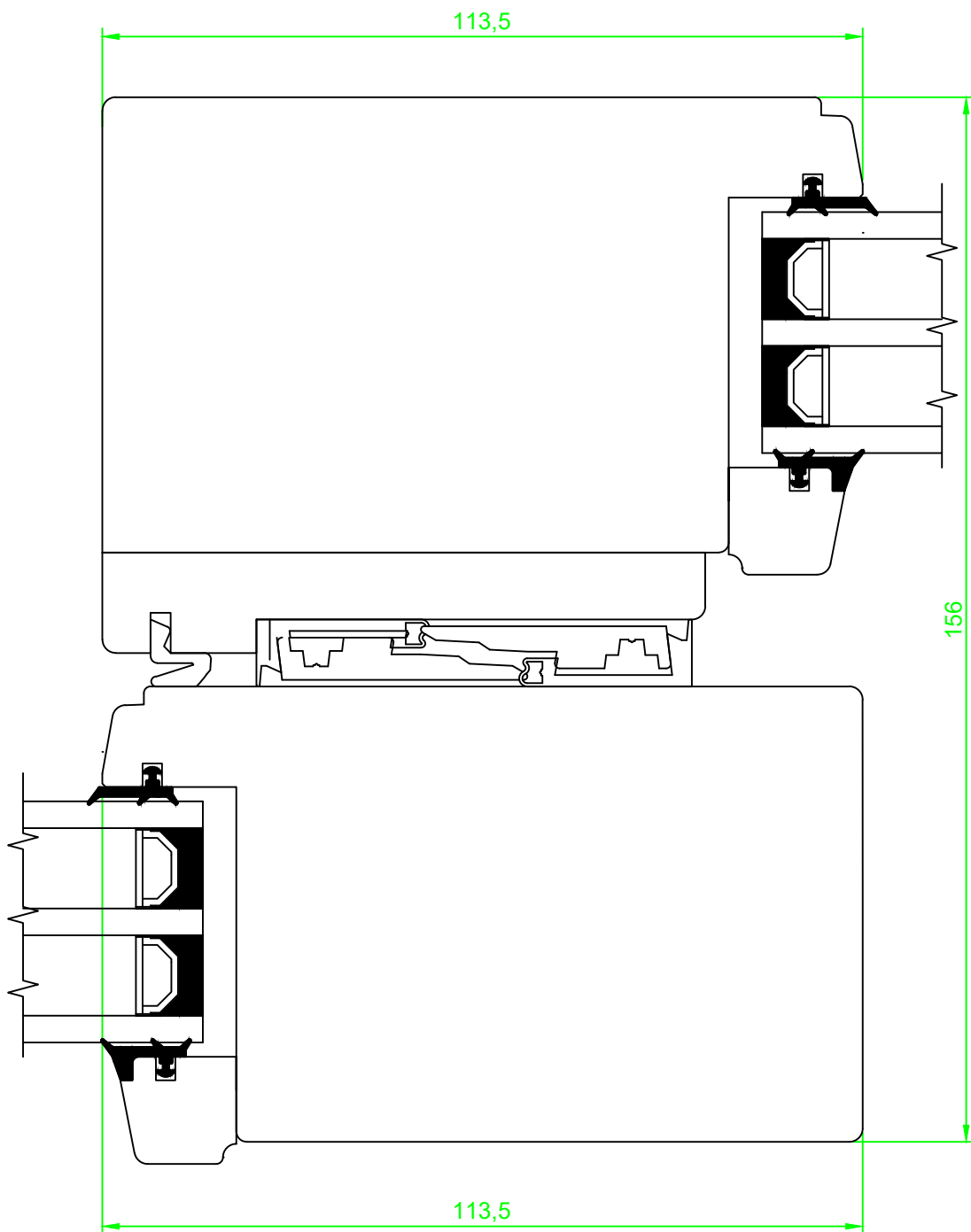

<i>Date.</i> 13.03.2017	<i>Constr./draw.</i> RS/EAO	<i>Approved.</i>	<i>Scale.</i> 1:1	<i>Review nr.</i> Rev. 2
Hev og senk skyvedør med GU beslag			<i>Material.</i>	 <small>Nordvestvinduet AS N-6713 ALMENNINGEN Tel: +47 57 85 25 99 firmapost@nordvestvinduet.no www.nordvestvinduet.no</small>
			<i>Replacement for:</i>	
<i>Tolerance.: NS-ISO 2768-1-middels.</i>			<i>Replaced of:</i>	

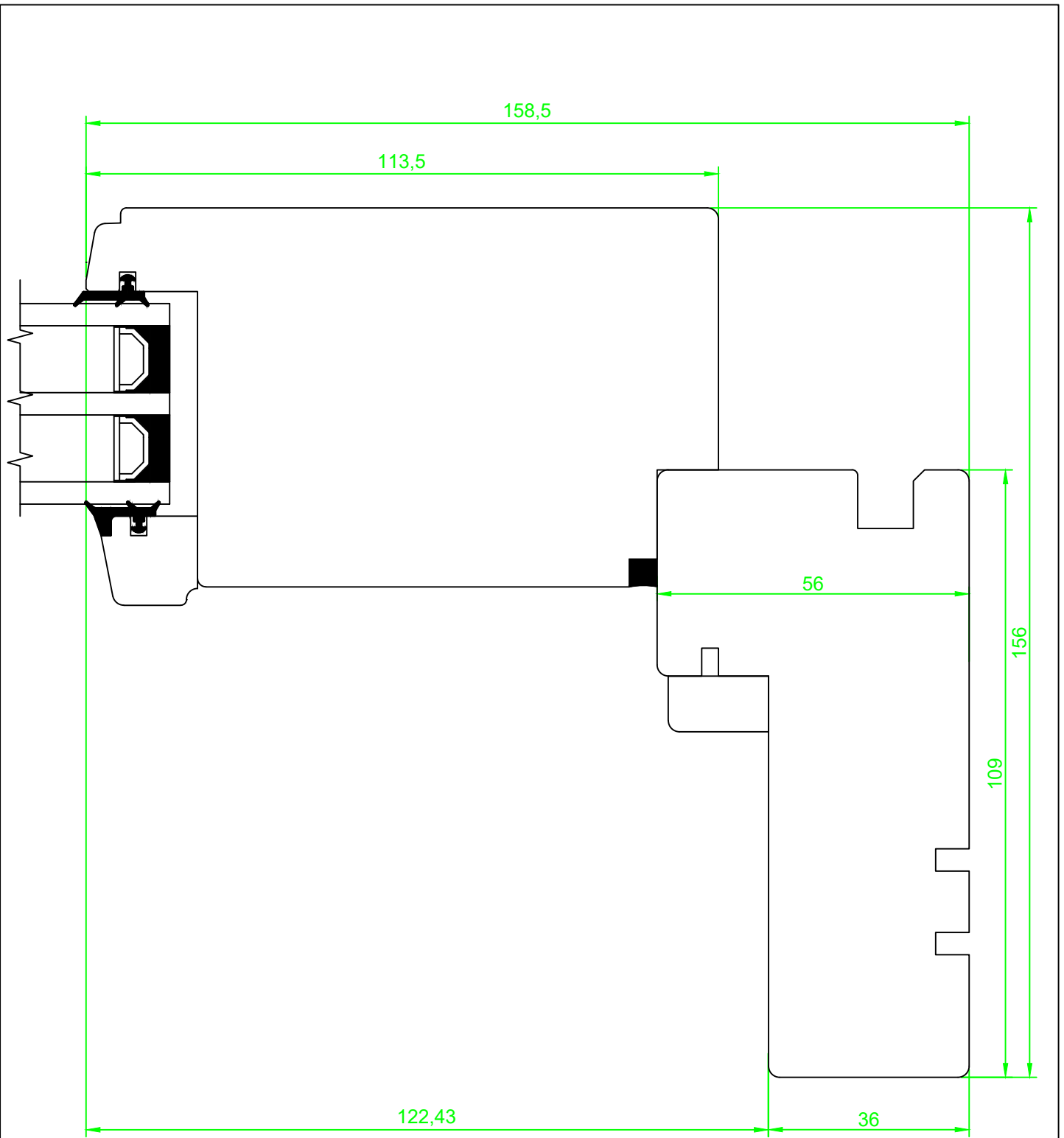

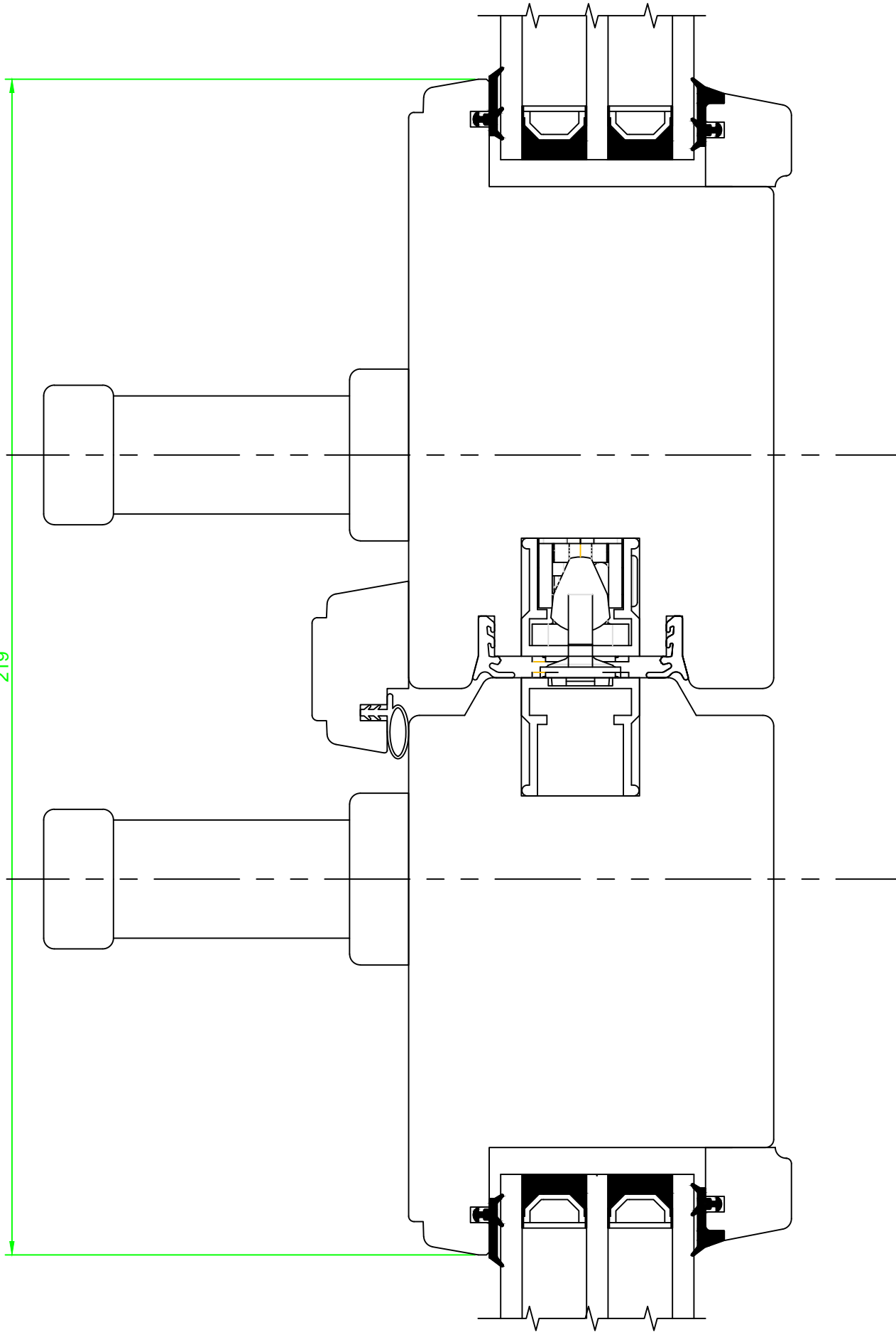

Date. 13.03.2017	Constr./draw. EAO	Approved.	Scale. 1:1	Review nr. Rev. 2
Hev og senk skyvedør med GU beslag Horizontalsnitt, detalj fastfeltside			Material.	 Nordvestvinduet AS N-6713 ALMENNINGEN Tel +47 57 85 25 80 firmapost@nordvestvinduet.no www.nordvestvinduet.no
			Replacement for:	
Tolerance.: NS-ISO 2768-1-middels.			Replaced of:	

219

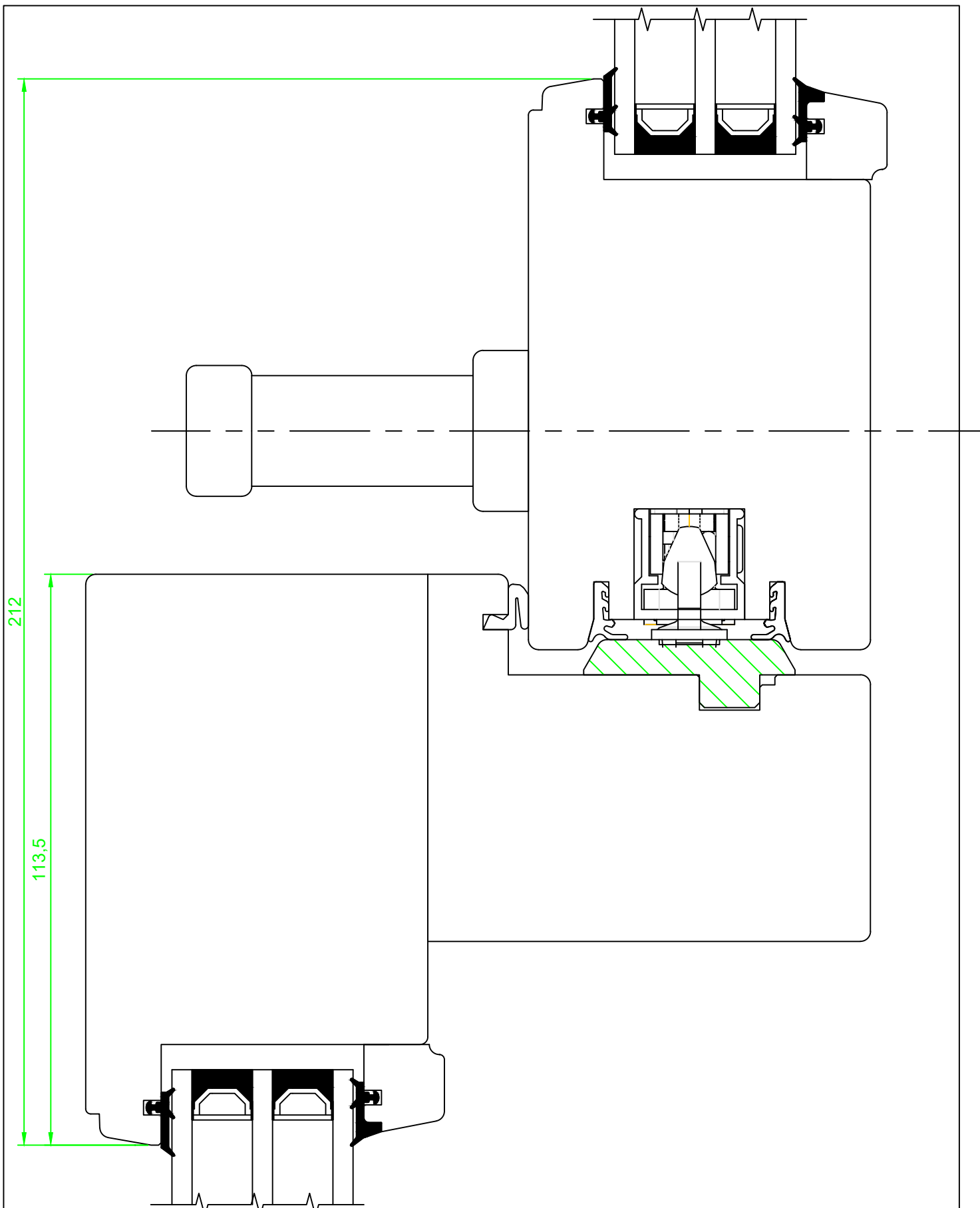

Dato:	14.02.2017	Konstr./Tegnet:	EAO	Godkjent:		Målestokk:		Rev. nr.:	Rev. 2
		Hev og senk skyvedør med GU beslag				Materialer:		HISTORISKE DATA Historisk informasjon	
		Horisontalsnitt, detalj midt SD4				Ersattning for:		Tegning nr. SD_STD_G36_SD4	
						Ersattet av:			
Toleranser.: NS-ISO 2768-M-kvalitet.									



<i>Date.</i> 13.03.2017	<i>Constr./draw.</i> EAO	<i>Approved.</i>	<i>Scale.</i> 1:1	<i>Review nr.</i> Rev. 2
Skyvedørpost SDT3 Horisontalsnitt			<i>Material.</i>	 Nordvestvinduet AS N-6713 ALMENNINGEN Tel +47 57 85 25 80 firmapost@nordvestvinduet.no www.nordvestvinduet.no
			<i>Replacement for:</i>	
<i>Tolerance.: NS-ISO 2768-1-middels.</i>			<i>Replaced of:</i>	