

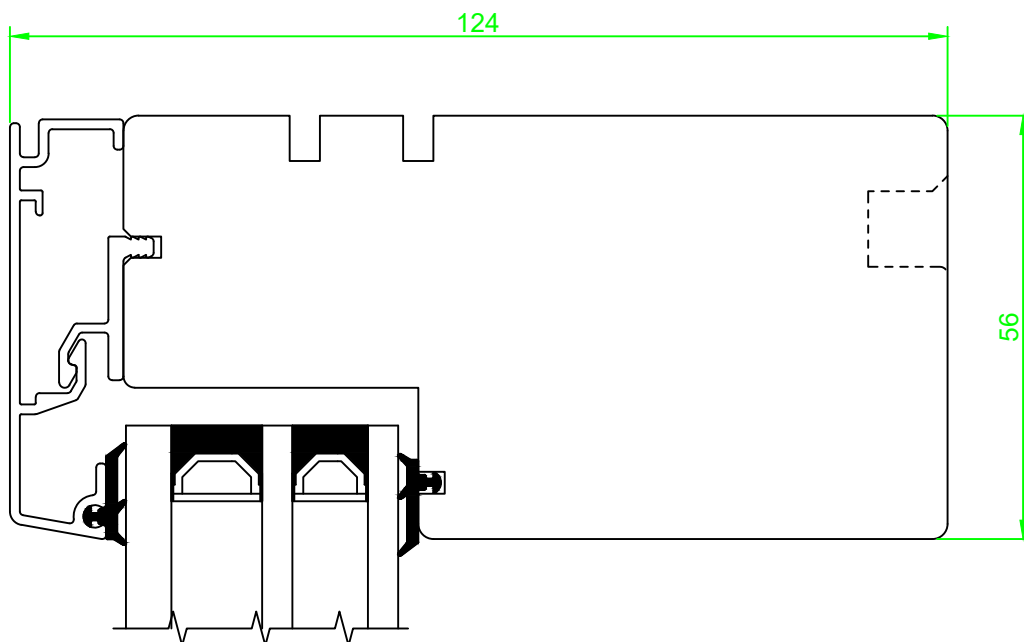



| | | | | |
|--|----------------------------------|------------------|--------------------------|--|
| <i>Dato.</i> 12.01.2016 | <i>Konstr./Tegnet.</i> JA/EAO | <i>Godkjent.</i> | <i>Målestokk.</i> 1:1 | <i>Ref. nr.</i> Rev. 2 |
| Fastkarm vindu i tre/aluminium 109+15mm karm, 39mm fals Vertikalsnitt bunn, design trend | | | <i>Materiale.</i> |  <small>Nordvestvinduet AS N-6713 ALMENNINGEN Tel +47 57 85 25 80 firmapost@nordvestvinduet.no www.nordvestvinduet.no</small> |
| | | | <i>Erstatning for:</i> | |
| <i>Toleranse.: NS-ISO 2768-1-middels.</i> | | | <i>Erstattet av:</i> | |



| | | | | |
|--|-------------------------------|------------------|--------------------------|---|
| <i>Dato.</i> 10.09.2009 | <i>Konstr./Tegnet.</i> EAO | <i>Godkjent.</i> | <i>Målestokk.</i> 1:1 | <i>Ref. nr.</i> Rev. 2 |
| Fastkarm vindu i tre/aluminium 109+15mm karm, 39mm fals Vertikalsnitt topp, design trend | | | <i>Materiale.</i> |  <small>Nordvestvinduet AS N-6713 ALMENNINGEN Tel +47 57 85 25 80 firmapost@nordvestvinduet.no www.nordvestvinduet.no</small> |
| | | | <i>Erstatning for:</i> | |
| <i>Toleranse.:</i> NS-ISO 2768-1-middels. | | | <i>Erstattet av:</i> | |

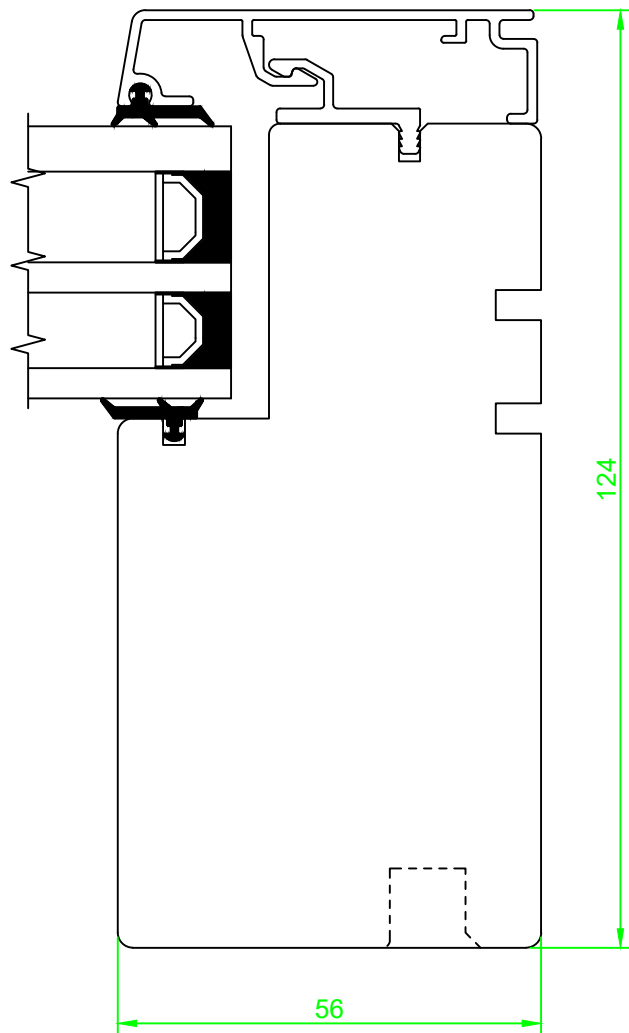

| | | | | |
|--|-------------------------------|------------------|--------------------------|---|
| <i>Dato.</i> 10.09.2009 | <i>Konstr./Tegnet.</i> EAO | <i>Godkjent.</i> | <i>Målestokk.</i> 1:1 | <i>Ref. nr.</i> Rev. 2 |
| Fastkarm vindu i tre/aluminium 109+15mm karm, 39mm fals Horisontalsnitt side, design trend | | | <i>Materiale.</i> |  <small>Nordvestvinduet AS N-6713 ALMENNINGEN Tel +47 57 85 25 80 firmapost@nordvestvinduet.no www.nordvestvinduet.no</small> |
| | | | <i>Erstatning for:</i> | |
| <i>Toleranse.:</i> NS-ISO 2768-1-middels. | | | <i>Erstattet av:</i> | |

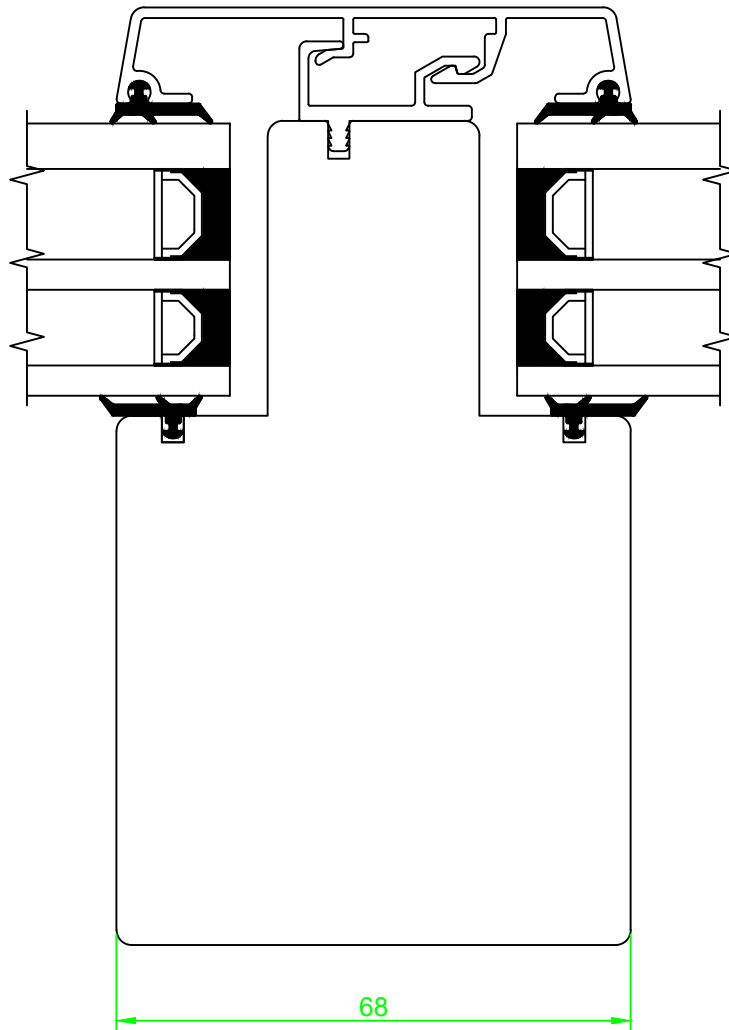

| | | | | | |
|--|----------------------------------|------------------|--------------------------|---|--------------------|
| <i>Dato.</i> 29.11.2012 | <i>Konstr./Tegnet.</i> JA/EAO | <i>Godkjent.</i> | <i>Målestokk.</i> 1:1 | <i>Ref. nr.</i> Rev. 2 | |
| Fastkarm vindu i tre/aluminium 109+15mm post, 39mm fals Horizontalsnitt post, design trend | | | <i>Materiale.</i> |  <small>Nordvestvinduet AS N-6713 ALMENNINGEN Tel +47 57 85 25 80 firmapost@nordvestvinduet.no www.nordvestvinduet.no</small> | |
| | | | <i>Erstatning for:</i> | | <i>Tegning nr.</i> |
| | | | <i>Erstattet av:</i> | | FKA39_TR_P68 |
| <i>Toleranse.:</i> NS-ISO 2768-1-middels. | | | | | |

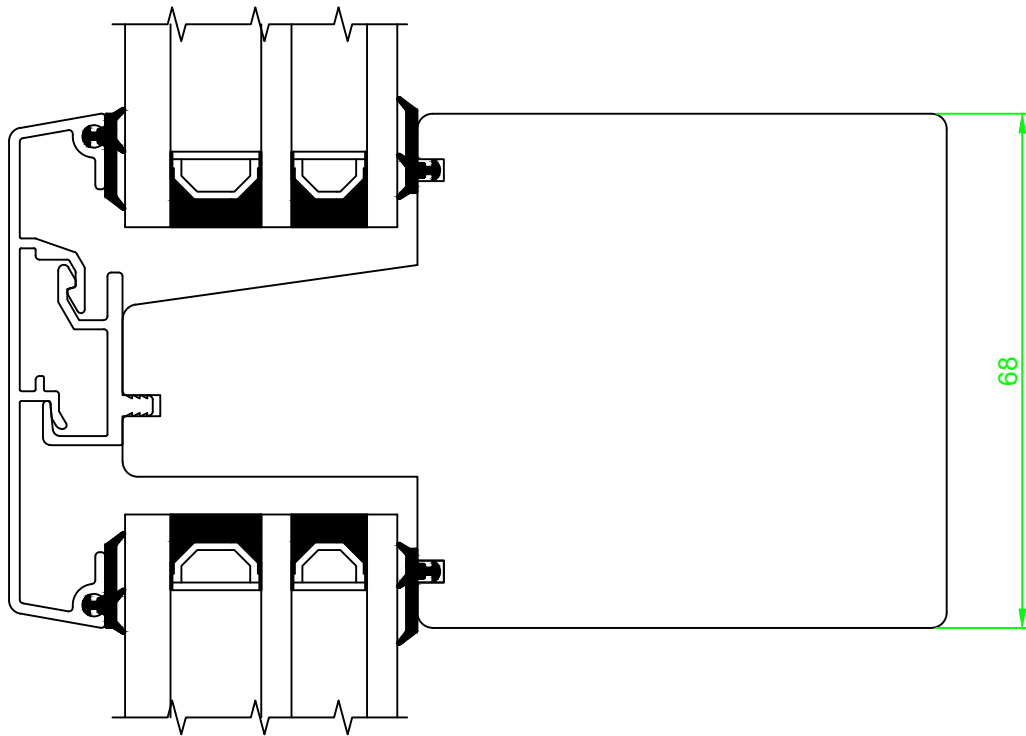

| | | | | |
|--|----------------------------------|------------------|--------------------------|--|
| <i>Dato.</i> 29.11.2012 | <i>Konstr./Tegnet.</i> JA/EAO | <i>Godkjent.</i> | <i>Målestokk.</i> 1:1 | <i>Ref. nr.</i> Rev. 2 |
| Fastkarm vindu i tre/aluminium 109+15mm losholt, 39mm fals Vertikalsnitt losholt, design trend | | | <i>Materiale.</i> |  <small>Nordvestvinduet AS N-6713 ALMENNINGEN Tel +47 57 85 25 80 firmapost@nordvestvinduet.no www.nordvestvinduet.no</small> |
| | | | <i>Erstatning for:</i> | |
| <i>Toleranse.: NS-ISO 2768-1-middels.</i> | | | <i>Erstattet av:</i> | |